

Coffey / Coffee Y-DNA Surname Project

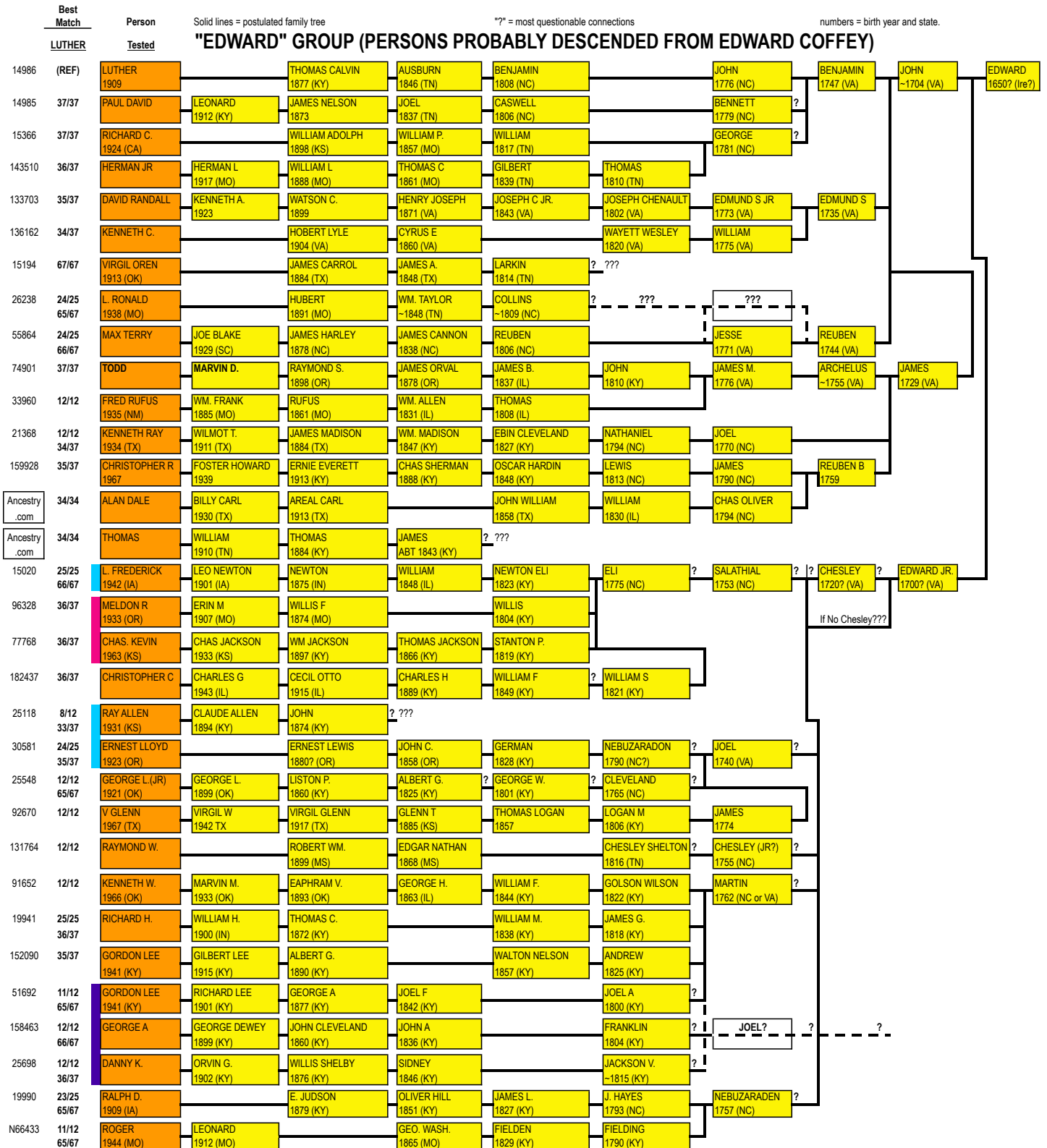

Coffey / Coffee Y-DNA Surname Project

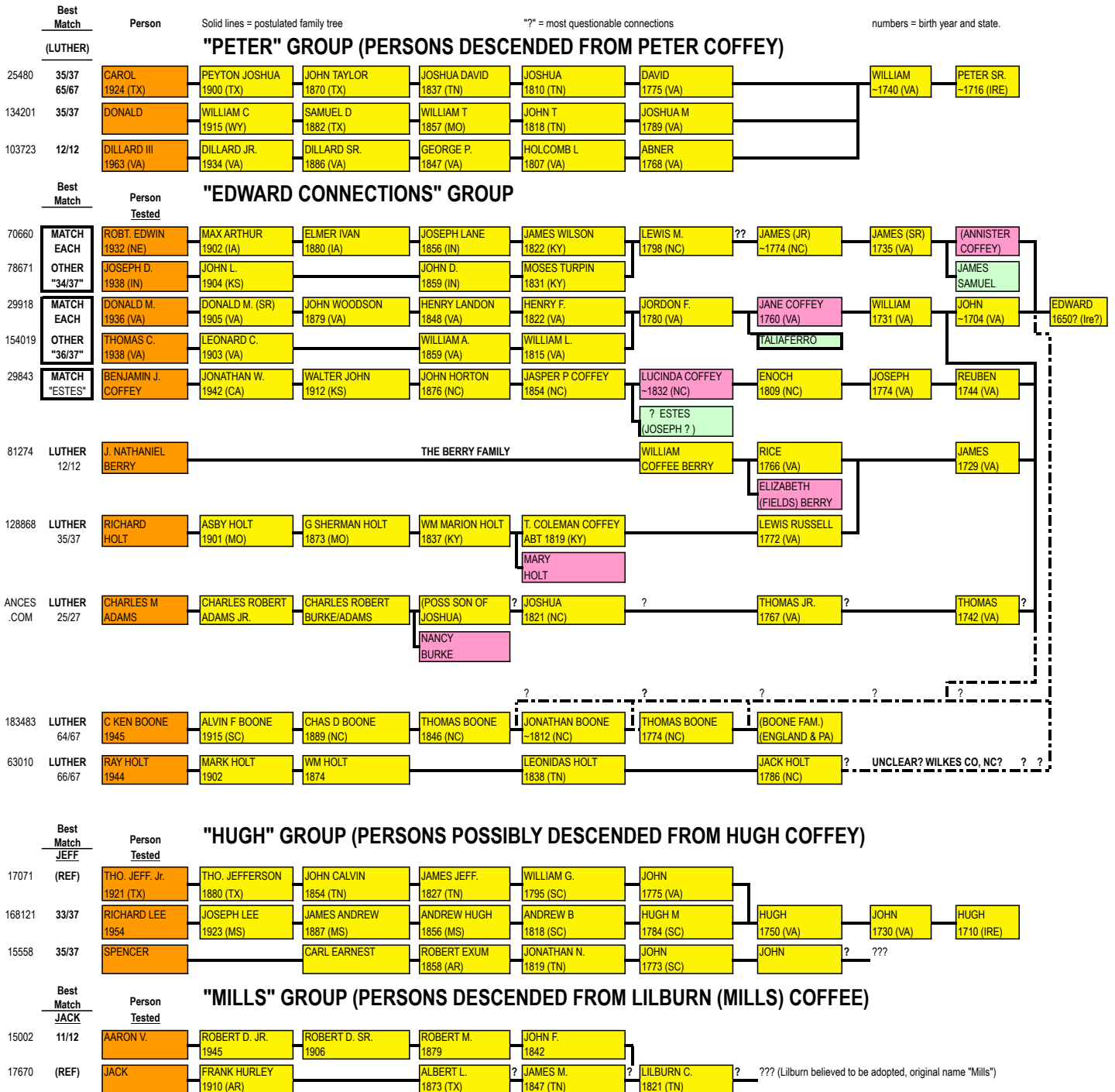

Coffey / Coffee Y-DNA Surname Project

Best Match Person Solid lines = postulated family tree "?" = most questionable connections numbers = birth year and state.

"NORTHERN USA" GROUP:

Best Match	Person	Person	Person	Person	Person	Person
79519 (REF)	JAMES M. (JR) 1965 (NY)	JAMES M (SR) 1942 (NY)	JAMES J. 1896 (PA)	MICHAEL 1867 (IRELAND) ?		
169886 67/67	PAUL BRANCKY	LEO BRANCKY 1920 (IL)	<< LEO ADOPTED SEE NOTE >>	FRANK COFFEY 1868 (IRE) ?	LEO BRANCKY WAS ADOPTED. CIRCUMSTANTIAL EVIDENCE IS THAT HIS GRANDFATHER WAS FRANK COFFEY. FRANK BORN IRELAND 1868, IMMIGRATED APT 1880/83, SETTLED IN CHICAGO AREA.	
47117 66/67	RBT. EUGENE 1939 (MI)	EUGENE C. 1913 (MI)	DANIEL FRANCIS 1870 (MI)	DANIEL F. 1841 (IRE)	DANIEL (IRELAND) ?	
60918 66/67 36/37	STEPHEN 1951 (CA)	HERBERT 1924 (CA)	HERBERT 1897 (CA)	WILLIAM 1869 (CA)	WILLIAM 1845 (NY)	JAMES 1804 (IRELAND) ?
31891 34/37 64 / 67	JAMES (JR)	JAMES EDWARD 1913 (NY)	WILLIAM 1877 (NY)	WILLIAM 1845 (CORK, IRE)		
178093 12/12	JOHN JOSEPH 1948 (MA)	WILLIAM EDWARD 1913 (MA)	JEREMIAH C 1874 (MA)	JAMES 1849 (IRE) ?		
139027 34/37 63 / 67	DAN ALAN ROSS 1956 (TX)	DANIEL R ROSS 1923 (TX)	DANIEL W ROSS 1896 (OK)	CHARLES ROSS 1864 (MS?LA?) ?		(NOTE: Best match is to the 2nd James, Sample #31891)

"COUNTY MEATH" GROUP

Best Match	Person	Person	Person	Person	Person	Person	Person	Person
85718 (REF)	DAVID LYNN	LAWRENCE H 1924 (TN)	AMBROSE M. 1902 (KY)	JOSHUA 1865 (KY)	ELIJAH 1798 (KY)	AMBROSE 1759 (CO. DUBLIN)		
121709 12/12 34/37	JOHN WILLARD 1962 (OH)	JOHN WILLARD SR 1937 (OH)	ARTHUR ROY 1904 (OH)	ROBERT STAR 1866 (KY)	ROLLEY 1829 (KY)	AMBROSE JR. 1787 (KY)		
127425 12/12 34/37	JAMES JOSEPH 1930 (NY)	JAMES JOSEPH SR 1894 (DUBLIN)						
72279 12/12 29/37	VERNON C. 1923 (IA)	CHRISTOPHER 1889 (CO. MEATH IRE)	CHRISTOPHER 1860 (CO. MEATH)	CHRISTOPHER 1807 (CO. MEATH)	MICHAEL 1777 (CO. MEATH)	MAURICE ?? (IRELAND)		
45425 12/12 30/37	WILLIAM J. H. (NJ)	JOHN H. JR 1918 (NJ)	JOHN HILLMAN 1880 (NJ)	EUGENE M. 1880 (NJ)	SAMUEL HILLMAN 1849 (PA)	WILLIAM F. 1811 (NJ)	ISAAC ZANE 1776 (NJ)	JAMES JR. ? (PA) ? (?)
207121 12/12 29/37	LAWRENCE E	ALVIN LOUIS 1903 (LA)	RICHARD FRENCH 1860 (LA)	JOHN FRENCH 1826 (LA)	BERNARD 1798 (C WESTMEATH)	JOHN C. WESTMEATH		

"IRISH COFFEY" GROUP

Best Match	Person
76986 (none)	FINTAN (IRELAND) ? ???
22504 (none)	SEAN (IRELAND) ? ???

"UNKNOWN" COFFEY GROUP(S)

Best Match	Person	Person	Person	Person	Person	Person	Person	Person
32224 (none)	ALAN DALE (OK)	LAWRENCE D. 1929 (OK)	HUBERT DENSON 1905 (OK)	JOEL W.L. 1874 (AL) ?	JOHN JAMES 1851 (AL) ?	JOEL W. 1819? (AL?) ?		
22504 (none)	DAVID ? ???							
21180 (none)	JAMES WM. 1948 (AR)	DOLPHA C. 1914 (AR)	JAMES H. 1872 (AR) ? ???					
52029 (none)	THEODORE W 1937 (MD)	FRANCIS WADE 1907 (MD)	MATTHEW B 1875 (MD)	PATRICK JR. 1842 (MD)	PATRICK 1808-14 ?			
82799 (none)	PATRICK ASA 1940 (TX)	LEROY 1887 (TX)	THOMAS (TN) ?					
90156 (none)	J. RUSSELL 1898 (OH)	GEORGE 1869 (OH)	MICHAEL 1837 (OH)	? (IRELAND) ?				
91636 (none)	FRANK F. (MN)	FRANCIS S. 1906 (MN)	JOHN F. 1874 (MN)	ANTHONY A. 1836 (IRELAND)	JOHN (IRELAND) ?			
95987 (none)	DOUGLAS G	GEORGE M. 1894 (MO)	RICHARD N 1868 (MO)	WILLIAM A 1821 (KY)	RICHARD N 1795 (VA) ?	OSBORNE 1759 ?	WILLIAM 1731 (VA) ?	

Last Update: 10/15/11