

Coffey Family History and Genealogy

a few beginning family charts

Please return all
additions and corrections
to
John Taylor
1417 Claremont Avenue
Richmond, VA 23227

Coffey Family History and Genealogy - Coffeytown Settlers and their Descendants

Table of Contents

A. Introduction

B. Original Coffey Family in Amherst County

C. Original Coffey Settlers - Family Charts

- 1. Hudson "Huddie" and Mahala (Green)(Lane) Coffey**
- 2. Schylar and Elizabeth (Hamilton) Coffey**
- 3. John Jack and Elizabeth "Betsey" (Duff) Coffey**
- 4. William "Billy" and Sarah Anne "Sally" (Crawford) Coffey**
- 5. Nelson and Rebecca (Hamilton) Coffey**
- 6. Henry and Elizabeth (Ogden) Coffey**
- 7. Susanna (Coffey) and John Crawford, Jr.**
- 8. Jane (Coffey) and Meredith Allen**
- 9. Elizabeth (Coffey) and John Hamilton**

D. Chronology of Early Coffeys in Virginia as shown in the Public Records

(July, 1992)

Introduction

Coffey Family History and Genealogy - Coffeytown Settlers and Their Descendants

Introduction

Although the Coffey family was not the first family to settle in the area now shown on the map as "Alto", this family did settle in such proportions that the small community grew to be called "Coffeytown" by the local neighbors. The origins of the Coffey family in Amherst County are the origins of Coffeytown. Our interest is primarily in developing an appreciation for the previous owners and users of our recently purchased property, and the immediate vicinity, in Coffeytown.

The basic outline of the family charts in this book was furnished by Elsie and Tommy Coffey; Mrs. Joyce Coffey Mason and Mrs. Thelma DePriest (Daniel Rufus); Hersey Coffey for his portion of the family; and Mrs. Diane Gardner for her Bristol, Tennessee branch of John Jack Coffey descendants. Additional verbal information was provided by various family members and incorporated into the charts.

Verbally furnished information is not considered sufficiently reliable information to form a valid genealogy; however, one must start somewhere. The original settlers, their ancestors and their children have been researched through public records available in the Virginia State Archives. This is the status of the charts included herein. Unless footnotes are given, all information provided in the charts is preliminary - to be verified with reference to written historical documents. Our interest has been essentially satisfied, in researching the original settlers and being able to tie the names on the tombstones to those first settlers. Research regarding each family line of descent is beyond our interest, but this basic structure would be very helpful to anyone who wishes to seriously investigate his own line of descent.

Coffey Family Legend has it that the first Coffey settlers in Coffeytown were all brothers and sisters. The earliest Coffey settlers (second generation) were Hudson, Schylar, John Jack, William "Billy", Nelson and Henry Coffey, and women Elizabeth, Susanna, and Jane Coffey, a total of nine who were known to have lived, married, and had children in or around Coffeytown in Amherst County.

According to the census reports, the first Coffey to settle in what is now Amherst County was **Jordan Coffey**. He brought his wife - Elizabeth Rippetoe, daughter of Peter and Sarah Rippetoe - and nine children from Nelson County sometime during or before 1827. Jordan married Elizabeth on

21 March or May 1803 in what was then Amherst County but is now Nelson County. At this time Jordan had a guardian, Benjamin Fitzgerald. In the 1800 tax records, Jordan is listed as "Jordan Fitzgerald (alias Coffey)". Evidently his father was deceased, or left the family. His mother may have been a "Fitzgerald" who then went to live with her father or brother Benjamin. This part of the ancestry is not clear in the records. Neither Jordan nor Elizabeth appear in any of the death records which might shed some light on his ancestry, nor did he leave a will. I've found no evidence to suggest that he owned any real estate, although his son Hudson deeded his mare, bed and some furniture to his father in Amherst County in 1827. None of the deed book indexes in the state archives list Jordan as an owner of real estate, within the timeframe of his life. Further research into the guardianship question is ongoing, but this is laborious - searching through court records which are not indexed. Indeed there may not have ever been a formal guardianship established. To establish lineage, Jordan's parents must be verified.

The record is clear that all three of the daughters, sons John Jack, Billy, and Hudson Coffey were the children of Jordan and Elizabeth Coffey. All were verified through marriage records. Specific references to the parentage of Nelson and Schylar Coffey were not found. Henry Coffey's parents were listed on his death record as Charles and Jane Coffey of Nelson County. Although this information was furnished by his son Henry, it doesn't make sense since there were no Charles and Jane Coffeys of the proper age in Nelson County (as heads of household) that we could find, at the time. Some Henry Coffey appears in Rockbridge County on the 1810 Census Index, 7 years before this Henry was born. Evidently there were more than one or two Henry Coffeys around and the records are consequently difficult to understand. The death record could be for a different Henry, but I doubt that any other Henry Coffey in Amherst County would have been born in Nelson County, married an Elizabeth, and had a child named Henry, as well as living in the same time-frame. On the other hand, why would his son guess at his grandparent's names if he didn't know? Many death records don't list parentage because the survivors simply didn't know. It is possible that Henry F. thought he knew and was simply mistaken, or that Charles and Jane lived their lives and had their children without ever becoming heads of a household, at least not at census-report-time. Research is continuing. It would be very difficult to prove the death record wrong.

In the 1830 census, only the head of the household is listed by name. The other persons living in the house are listed by gender and age bracket. Later census reports list each individual's age, although not always accurately. Comparing later reports with the 1830 census, the age brackets work out for all the Coffey children except the youngest (0-5 years old). None of the 9 children were that young in 1830. Possibly John Jack Coffey, who married in

January of 1830, was living elsewhere when the census was taken in the summer, perhaps renting a room, so he would not be listed separately as the head of a household. The youngest, ninth child may have died before the 1840 census, or may have been the young child of a cousin, living in the Coffey household for the summer. Since death records were not kept until 1853, and even then not all deaths were reported, this may remain a minor mystery. If John Jack was gone, and the ninth child died, which was all too common, this still leaves nine children. If Henry, Schylar, and Nelson were not part of them, who were the others? Family history is full of such mysteries, which is what makes it interesting. One possible theory is that all three of these Coffey males were taken in and reared by Jordan and Elizabeth, and all three knew who their biological parents were. It is possible that Charles and Jane were the parents of all three. Because Schylar and Nelson were so much older than Henry, there may have been other children involved who were "farmed out" to other Coffeys. If the children were adopted informally, say upon the death of Charles and/or Jane, there would be no record. Jordan, having had first hand experience with guardianship, may have insisted that his informally adopted children be aware of their biological heritage.

{Edmund F. Coffey of Nelson County had several children, among them William B. and John Coffey, but these are not Billy and John Jack. William B. and John lived their lives in Nelson County. William B. drowned at the age of 60 in Nelson County in 1867, Billy Coffey appears in census reports in Amherst years later (1870). The belief that Edmund F. is the ancestor may stem from the fact that Amherst County once incorporated Nelson County, and records for those persons in what is now Nelson County appear in the pre-1807 records of Amherst County. However, the 1810 and 1820 census reports, taken just after the counties separated, show no Coffeys/ Coffees/ Coffys in Amherst County until 1830, and then only Jordan Coffey and his family of eleven. Later census reports show Jordan, Elizabeth, and Hudson living together and within the community of Coffeys in Pedlar district of Amherst County, including John Jack; and Billy. It is clear to me from the public records examined to date that Jordan and Elizabeth are the parents of John Jack, Billy, Hudson and the three daughters. The jury is still out on Henry, Schylar, and Nelson. They may have been brothers themselves, but cousins to John Jack and Billy. They may have been living with Jordan's family, or came along later, independent of Jordan and Elizabeth.)

The first deed for real estate owned by a Coffey in Amherst County, which appears in the deed books at the State Archives, lists Nelson Coffey and others as owning 170 acres which had been previously owned and lived-on by Robert Hamilton, father of Rebecca Coffey (Nelson's wife), John Hamilton (Elizabeth Coffey's husband), and Elizabeth Hamilton Coffey (wife of Schylar Coffey). This occurred in 1842, some years after Jordan's family moved into

Amherst County, and as a result of a lawsuit presumably over the question of inheritance of the land and house. (This may have been the connection which brought Schylar and Nelson Coffey to Amherst County. The marriage of Jordan's daughter Elizabeth into the Hamilton family may have been the reason the two groups ended up living more or less together in Coffeytown.) Other information indicates 1825/1832 as a date of first purchase of land in Amherst County by the Coffey family, but this has not been verified in the County Deed Books (none of these show in the indexed listings in the State Archives, but they may still be true dates. Most of the Coffeys of this era were illiterate, and may not have recognized the necessity of recording deeds.)

Apparently all of the boys and none of the girls settled in the Coffeytown area. Based on census reports, the oldest was Hudson, then Schylar, John Jack, Billy, Nelson and Henry. Since the girls went with their husbands to places other than Coffeytown, they are listed at the end of the Original Family charts. Evidently none of their offspring were instrumental in settling Coffeytown. The earliest marriage was John Jack in 1830. Between 1830-1835 all the others except Hudson and Henry had taken first spouses. Hudson may have been the first Coffey in Amherst County, who then convinced his parents and siblings to come to Amherst County, where all were married within a few years of their arrival. Henry married in 1848, Hudson did not marry until 1855. Both parents (J & E) appear in Amherst in the 1830, 1840 and 1850 census reports, neither appear in the 1860 or later census reports anywhere in Virginia. Apparently, both Jordan and Elizabeth Rippetoe died between 1850-1860, but neither death was reported to the Courthouse. (This implies death before 1853, when the law went into effect requiring the County Clerks to keep vital statistic records.) Perhaps only then (1855) did Hudson marry. He seems to have been very dedicated to his parents.

Apparently Henry Coffey's wife had been previously married and those first children, births dating back to 1830, were hers by a previous marriage. They may have taken his surname in much the same way that Jordan used the Fitzgerald name prior to marriage. When Paulin Coffey died, his will clearly indicates Henry as his guardian, not his father. It seems that only Avarilla Coffey Davis, Henry F. and Mary Coffey Crawford were blood offspring of Henry Coffey. Strangely, Avarilla was just a little younger than Paulin, and she seems to have been born somewhat before Henry and Elizabeth were married.

Nelson Coffey seems to have died fairly young, between 1844-1849. He was apparently alive when the court awarded property in early 1842, and alive late enough for Rebecca Hamilton his wife to become pregnant with little Nelson, who was 5 years old in 1850. Apparently he was dead when his wife Rebecca remarried, to an Abram Clement, 5 years her junior, in 1849. Abram was

killed in the Civil War in Harrisonburg on 6 June 1862. In 1870, 55 year old Rebecca is again the head of the household, with 19 year old John Clement and 21 year old "Missouri?" Clement, her daughter, living in. Pauline, Nelson's daughter, was 28 in 1870, and living with Edward Drummond (45), Moses Coffey (6), and William Coffey (2), probably her children. At the age of 36, Pauline applied for a marriage license but the record is not clear if the marriage took place. She may have been married earlier but I have found no record of her marriage. Both Nelson and Rebecca were illiterate.

Schylar Coffey may have actually been Schyuler Coffey, as his name is sometimes written. If so, both he and Nelson have geographically derived names. There was a group of Coffeys and Rippetoes at the northeast foot of Piney Mountain in what is today Nelson County, according to early deeds. A small portion of the Schyuler District dips down into an area at the northeast foot of the Piney Mountain. Nelson was born around the time this area became Nelson County (1807). None of the records we've found to date list his parents. He left no will and his death was not reported, although he lived beyond 1853. Henry is also the name of a county (formed 1777). It is entirely possible that Henry, Schuyler, and Nelson were brothers, all the sons of Charles and Jane Coffey, but this is pure speculation at this time. Additional documentation is needed to establish the parentage of Nelson and Schylar Coffey.

In researching the Coffey family we found that the surname originates from the Irish "O'Cobhthaigh" which means "victorious".

Apparently the very first Coffey to see Virginia was John Coffey, in 1637. He could have been a crew member on the ship and may have returned to Ireland/England the same year. We have not found any evidence that he stayed. Jamestown was only 20 years old at the time. Another possible Coffey, Abraham Cofface (sic), came to Virginia in 1653, but again, no further record.

The earliest found reference to Coffey settlers in Virginia is to a Edward Coffey who had a wife, Ann Powell, daughter of Thomas Powell, and 2 sons, John and Edward, along with daughters Martha, Ann, Annister, and Elizabeth, according to his will, dated 14 February 1715, filed in Essex County, and probated 20 November 1716. Edward and Ann were married in 1700 in Essex County. Edward earned his "freedom, corn, and clothes" from Benjamin Mosely on 4 April 1706, in Essex County. This is a strong implication that Edward Coffey came over as an indentured servant to Benjamin Mosely, although his name does not appear in the passenger lists of early immigrants.

(I understand that there was a law in the early colonial days which required those without visible means of support to become indentured. This applied to long time inhabitants as well as newcomers.) Indentured servants usually served for seven years, although the term varied. Edward may have arrived in 1699, or he may have received an early release upon the death of his master. Upon the death of Benjamin, William Mosely administered the will which gave Edward his freedom. In 1714 Edward sold 118 acres of land on the branches of Occupatia Creek to John Barbee in exchange for 500 pounds of "lawful sweet scented tobacco". Edward had previously bought this land from Augustine Smith who continued to live adjacent to Edward. Remarkably, Edward Coffey owned land as early as 10 October 1707, when Mr. Smith sold 93 acres to Henry Martin, such acreage being adjacent to Edward Coffey's land. For a man who had just been granted his freedom, corn, and clothes only 18 months earlier, Edward moved rapidly. According to The Planters of Colonial Virginia, by Thomas Wertenbaker, 1922, less than five percent of the indentured servants ever became landowners.

On 16 July 1716, sons Edward and John Coffee bought 200 acres along the same creek in exchange for 8000 pounds of tobacco to John Mosely, perhaps the son of Benjamin Mosely. This is the property known as Mosely's Quarters, and is located on a branch of Occupatia Creek, perhaps adjacent to land owned by their father and his former master.

John Coffey, son of Edward Coffey, married Jane Graves and they had James Coffey in Essex County in 1729 (secondary source of information). Edward's wife Ann evidently remarried a Duling. Her will, dated 1744, deeds property to her daughter Annister Coffey and grandson James Coffey. Perhaps grandson James was John's son James.

Tobacco was the economic mainstay of the seventeenth century colonies. Although the British often siphoned off much of the profits by means of tariffs and other taxes, tobacco was the means by which many yeomen made their "fortunes". While there were ups and downs over the years, the British Navigation Acts having had a profound effect upon planters' profits, the "end" of the tobacco gravy train was the last two decades of the seventeenth century, and the first decade of the eighteenth. Edward came in on the last wave of very high profitability in tobacco. Ultimately it was a sudden rise in the use of slaves which put the small planters at a disadvantage and forced many of them to look elsewhere for profits. The colonial government promoted many schemes for frontier settlement, including the award of property for military service. Caught in a profit squeeze, the Coffey's, like so many other colonial citizens, looked westward for land more suitable for crops other than sweet-scented tobacco. A John Coffey was involved in Dunmore's War (an Indian uprising in the upper Valley) in 1774 for which Lord Dunmore signed a

certificate for him to receive land in Virginia. It is not clear where the land may have been, even the County is not listed.

In 1748 a Peter Coffey bought 220 acres on Vaughan's Creek in Prince Edward County. By 1783, Susannah Coffee and 2 others were the only Coffees known by Census to be left in Prince Edward County, although there is some indication that General John Coffee, who had a brigade in Tenn in 1814, came from this area also. This Peter Coffey could be the one who was tried in London and sentenced to 14 years in prison in Potomack, Maryland. He came to the Colonies in chains in 1731; or some other Peter. Although there weren't many people around in those days, by today's standards, there was much repetition in given and surname combinations.

Reubin Coffey was born in Albemarle County in 1759, according to a secondary source. On 8 September 1760, some Edward Coffey made out a promisory note to Thomas Henderson, which he evidently could not pay, and ended up being arrested in 1762 to answer suit by Henderson. All this, and other legal proceedings concerning John Coffey, Sr., Cleveland, James, Thomas, Benjamin, and William Coffey occurred in what was then Albemarle County in the 1760's. (Albemarle included Amherst and Nelson at this time.) In Deed Book 2, John Coffey sold 124 acres to James Coffey on 9 March 1758. This property was at the heads of the branches of the Hardware River. In 1760 John Coffey, Jr. bought 90 acres from David and Rebecca Lewis at Michum River and Ivy Creek (now in Nelson County).

James Coffey of "Albermarle County" bought property from Thomas Jefferson on the Tye River in 1764. The purchase was witnessed by William Coffey who, 4 years later, bought 120 acres of it from James. If this James is the son of John Coffey previously mentioned, he would have been 35 years old at the time of purchase. On 26 February 1770 William and Ruth Rippetoe sold 200 acres to William Hall. This property was on the northeast side of Piney Mountain, bordering the property of Edward and Cleveland Coffey, in what soon became (1807) the Schuyler District of Nelson County.

In 1790, just one year after the Colonies became The United States, William Coffey, Jr. married Polly Rippetoe, possibly an older sister of Elizabeth who later married Jordan Coffey. In 1802, the year that Edmund Coffey married Elizabeth Burger, a William Coffey bought 215 acres of land on the Tye River from Peter and Sarah Rippetoe. This was approximately 6 months before Jordan married Elizabeth. Jordan's guardian Benjamin Fitzgerald shows up in 1810 clearly in Nelson County, and other evidence points to present day Nelson County, as the breeding grounds of the Coffeys who ultimately went southwest to settle "Coffeytown". Whether the Tye River group of Coffeys (perhaps descended from John Coffey, son of Edward Coffey) or the Ivy

Creek/Piney Mountain settlers (perhaps descended from Edward Coffey, son of Edward Coffey) is the ancestral pool for Coffeytown is not known at this time.

None of this discussion establishes a direct lineage of Coffeys back to Edward Coffey of Essex County. We have also found reference to a Hugh Coffey in Lancaster County, who seems to have been contemporary with the original Edward Coffey, perhaps his brother, but we have not yet found anything concerning his descendants. It will take a great deal more research to establish lineage. The key to the ancestry of Coffeytown inhabitants is Jordan Coffey and the current mystery surrounding the guardianship of Benjamin Fitzgerald. Court records, if a formal guardianship was established, could prove very helpful. If Jordan was ever christened or baptized, church records may name his parents. Then perhaps direct ancestry can be established and the line traced with some degree of certainty.

This booklet presents all that is known of the original 9 Coffey settlers in the first section of charts, "ORIGINAL COFFEY FAMILY IN AMHERST COUNTY". Each of the 6 males are repeated in later sections, in presumed order of birth, with a written article about each one. Behind each of the male's charts showing his immediate family are additional family charts of each grandchild and their descendants. Each grandchild is also presented in order of birth wherever that order is known. This progression continues as far down the genealogical ladder as information is available. If you have additional information, we would be pleased to add it to our charts, and continue to expand the list of descendants of those first Coffey settlers.

Records less than 75 years old are not readily available to the general public, so most of the remaining (current) lineage is based on verbal information. Census, birth, marriage and death records are not readily available at this time for verification of those generations. Some dates are taken from headstones and are so noted (these are not always accurate). Other dates, where estimated from census reports, are shown as "Ca.", meaning approximately. These are not always accurate either.

Jordan, Elizabeth and most of their children and ancestors were illiterate. Those who took census information were generally not much more capable. Misspellings and misdesignations are not uncommon, especially in rural counties, and the records are incomplete. Would a grief-stricken widow hitch-up the wagon and brave the 30 miles of mountainous terrain to the courthouse to tell a "revenuer" her husband or infant had just died in a snowstorm? Such information itself was often second hand and given only

when convenient, sometimes much later. Birth and death records are less reliable than marriage records with regard to actual dates. Unfortunately, the birth records for Amherst County are extremely faded and difficult to read on microfilm, so we have little of that information. The statewide index of births is also hard to read on microfilm, but we are making some headway.

Should you notice a mistake, or have additional, documented information, please notify us at the address indicated on the bottom of each sheet. Neither this information nor the charts is copyrighted. You are welcome to copy and distribute as you wish, but please keep in mind that this Genealogy/Family History is only an outline at this time. A fully developed family history takes years to develop and is almost never fully verified. Some of the family charts are more extensive than others because those who have taken the time to provide information are, naturally, more familiar with their own segments of the Coffey family.

Hopefully this small glimpse at the public records and the family charts will add some understanding to the ancestry of the Coffey family of present day Amherst County, provide some documented information regarding the early settlers of Coffeytown, and provide a framework for those wishing to seriously pursue Coffey family genealogy further.

John and Mary Anne Taylor
(July, 1992)

**Original Coffey
Settlers in
"Coffeytown"**

**Coffey Family History;
Original Coffey Settlers in "Coffeytown"**

Ca. 1780 *

Jordan Elizabeth
Coffe "Betsey"
Rippetoe
Coffey

In 1807, Nelson county was taken out of Amherst County. According to census reports, in 1810 and 1820 there were no Coffey families in Amherst County. Jordan "Fitzgerald" Coffey along with 10 other people (presumably 9 children) show up in Amherst in the 1830 Census. In 1840, there were 4 people in this Coffey household: 2 males aged 20-30, Jordan (50-60), and Betsey (60-70). Jordan was old enough to be the father of all the Coffey "Coffeytown" settlers. Sufficient indication of such has been found for most but not all of the original nine. Jordan may have been the guardian for some of the original settlers.

M: 21 MARCH 1803,
Amherst County 3

Ca. 1805, Amherst Co.*

Hudson Mahala
"Huddie" (Green)
Coffey (Lane)
Coffey

Joseph E. Coffey - Ca.1855 *

M: 20 SEPT 1855,
Amherst Co. His parents
were listed as Jordan and
Elizabeth Coffey.¹Hudson
was living with Jordan
and Betsey in 1850.
Mahala was a widow
when they married. No
information on whether
there were children by first
marriage.

Frances A. Coffey, Ca. 1834 *

George W. Coffey, Ca. 1836 *

Robert Coffey, Ca. 1839 *

Ca. 1806 *

Schylar Elizabeth
Coffey (Hamilton)
Coffey

Sophia (Coffey) Coffey, 1842 - 1932
married James "Jim" Coffey ²

M: 30 JAN 1832,
Amherst Co.³

Jordan Rebecca
Coffey P. (Grant)
Coffey Ca. 1842*
M: 3 JAN 1876,
Rckbrdg Co.⁶

Elizabeth was the
daughter of Robert
Hamilton.³

Ca. 1848 *
Schylar Isabella J. Mary S.
Coffey (Drumheller) (Coffey)
Coffey Coffey

M1: 5 MARCH 1868, Amherst
M2: 28 AUG 1880, Amherst ¹
Isabella's parents: A.S. and
Mary Drumheller; Mary's
parents: Rubin W. and SJB
Coffey. Schylar was a 32
year old widower when he
married 19 year old Mary.
Isabella died 17 FEB 1870
of heart discase.⁴

A license was applied for a wedding
to a 16 year old Ogden girl, 3
MAR 1875; not clear if marriage to
John ocured, but in November
1875, a John and Permelia Coffey
had a son.¹

John Permelia (?)
Coffey (Ogden)
Coffey Ca. 1849*

* family listings this chart based primarily on 1830-1860 Census Reports.

1. From Amherst County Marriage Records at State Archives (1853 - 1935).
2. Buried in Bridgehill Cemetery at Coffeytown; dates from headstones.
3. Amherst County Marriage records, 1801-1854, State Archives.
4. Amherst County Death Records (1853 - 1896).
5. In August 1895 Elizabeth Coffee, wife of Schylar, born in Amherst of unknown parents, died in Rockbridge Co. On 12 OCT 1895, their daughter Anne Belle Coffee also died of fever at age 14. Not known if this is the same Schylar, unlikely to be his father and mother, due to year of death, but no proof Schylar (2) married an Elizabeth.
6. Rockbridge County Marriage Records, Va. State Archives.

Continued next page

Please return any additions or corrections to John Taylor, 1417 Claremont Avenue; Richmond, VA 23227

**ORIGINAL
COFFEY
FAMILY IN
AMHERST[†]
COUNTY**

Chart 1 of 4
JULY, 1992

Coffey Family History; Original Coffey Settlers in "Coffeytown"

* listings are from 1840, 1850, and 1860 Census reports and oral history information; some dates from headstones

* A 10 year old Mark Coffey was listed in the 1850 Census, same house with John Jack and his family, no other mention in public records.

1809 - *

8
John Jack Coffey Elizabeth "Betsey" (Duff) Coffey

M: 18 JAN 1830, Ca 1805 - 14 AUG 1871³
Amherst Co.¹

1. From Amherst County Marriage Records in State Archives.

2. Buried in Bridgehill, dates from headstones.

3. Am Co Death records, she died of Cholera, born in Fluvanna County to Joshua and Besley Duff.

4. Never married, buried in family plot behind Elsie Coffey's house.

5. Am Co. Mar. records: parents were Rubin W. and S.T. Coffey; George was born in Nelson County.

6. Her parents were Avarilla and Wm W Davis.

7. From Morris R. Coffey.

8. On 1 APR 1873, a John Coffey, son of J and E Coffey, a 64 year old widower, married 25 yr old Virginia C. Campbell of Rockbridge County; a good indication John Jack was the son of Jordan and Elizabeth Coffey.

William "Billy" Coffey Sarah Anne "Sally" (Crawford) Coffey

1815 - 1817 -
1896 1906

M: 24 SEPT 1835, Amherst County. His parents were Jordan and Elizabeth Coffey.¹

continued

2 1832-1924

Charles E. Coffey and Sarah Jane (Ogden) Coffey

M: 14 FEB 1854, Amherst; her parents were Zachariah & Elizabeth Ogden; both Charles and Jane born in Amherst Co.¹

Jane: B: 22 OCT 1833; D: 17 JAN 1904⁷

Mary Coffey

Ca. 1835 *

John Jack Coffey, Jr. and Patara F. (Tyler) Coffey

1836 - 1907

William Henry Coffey and Virginia F. "Jenny" (Lawman) Coffey

1840 - ?

M: 16 APRIL 1868, Amherst; she was sister to Mildred Lawman, who married Daniel Rufus Coffey¹

Sarah Jane (Coffey) Davis and William N? Davis

M: 1859¹

1846 - 1921

Daniel Rufus Coffey,² Mildred (Lawman) Coffey, Sallie Cole (Black) Coffey

M1: 6 APRIL 1868, Amherst
M2: 30 AUG 1880; her parents were Cole and Sophia Black¹

2 1836 - 1915
1842 - 1932
James "Jim" Coffey and Sophia (Coffey) Coffey

2 1839 - 1914
Roxsinia (Coffey) Davis and Ben H. Davis

2 1843 - 1927
Ca 1849 *
William Coffey and Sarah Granville (Crawford) Coffey

2 1846 - 1937
1849 - 1935
Harden Coffey and Elizabeth "Bettie" (Crawford) Coffey

M: 14 FEB 1867, Amherst; her parents were Jas and Susan Crawford¹

4 1850 - 1907
Bettie Coffey

Ca. 1853 *
Edward Coffey and Willie Ann (Crawford) Coffey

M: 25 NOV 1875, Amherst¹

2 1856 - 1924
1853 - 1928
Sarah Fannie (Coffey) Coffey and George W. Coffey⁵

M: 7 MAR 1878, Amherst¹

6 1859 - 1945
1866 - 1951
Arthur Coffey and Virginia Anne "Jenny" (Davis) Coffey

M: 31 JAN 1884, Amherst¹

**ORIGINAL
COFFEY
FAMILY IN
AMHERST
COUNTY**

Chart 2 of 4
JULY, 1992

Please return all additions and corrections to John Taylor, 1417 Claremont Avenue; Richmond, VA 23227

**Coffey Family History;
Original Coffey Settlers in "Coffeytown"**

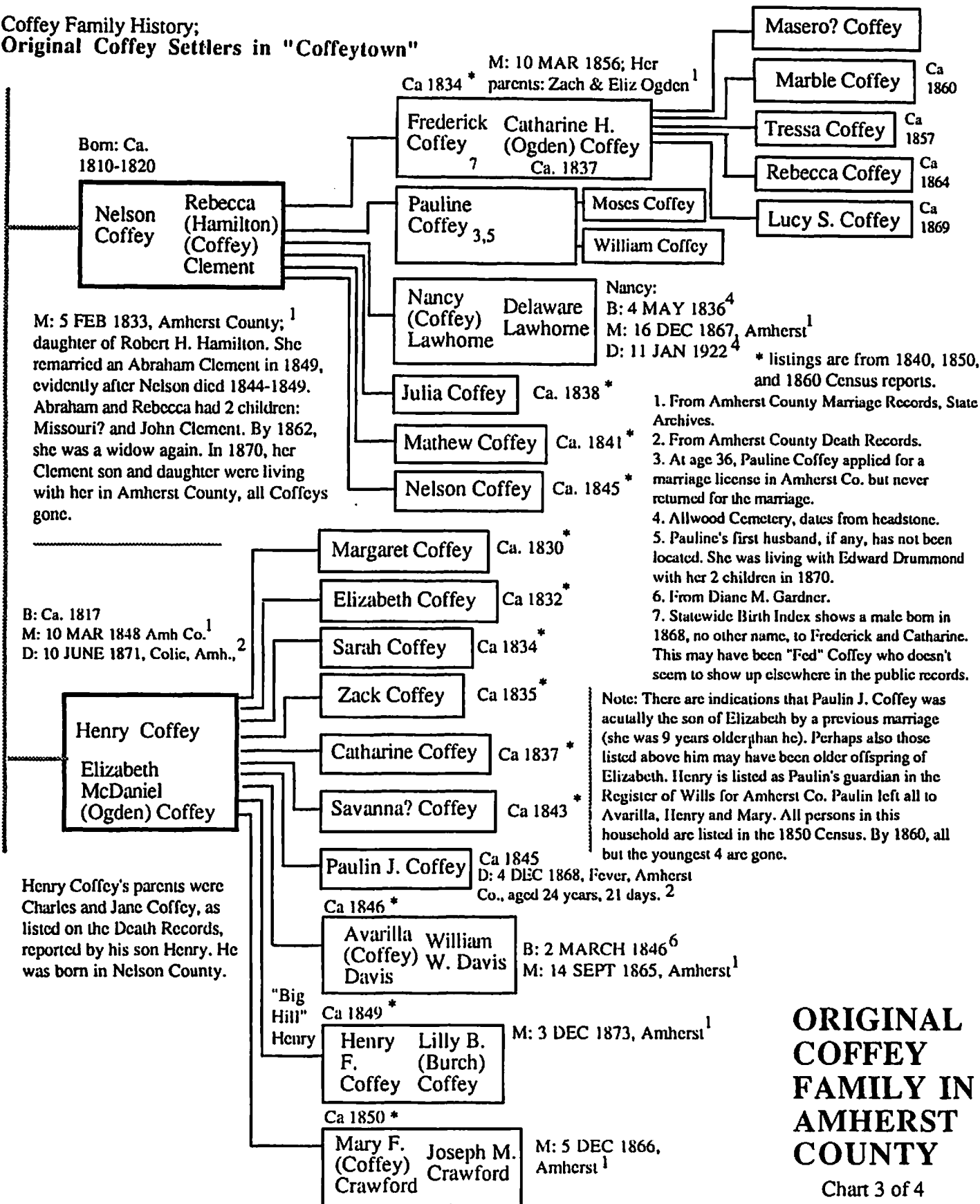

**ORIGINAL
COFFEY
FAMILY IN
AMHERST
COUNTY**

Chart 3 of 4
JULY, 1992

**Coffey Family History;
Original Settlers in "Coffeytown"**

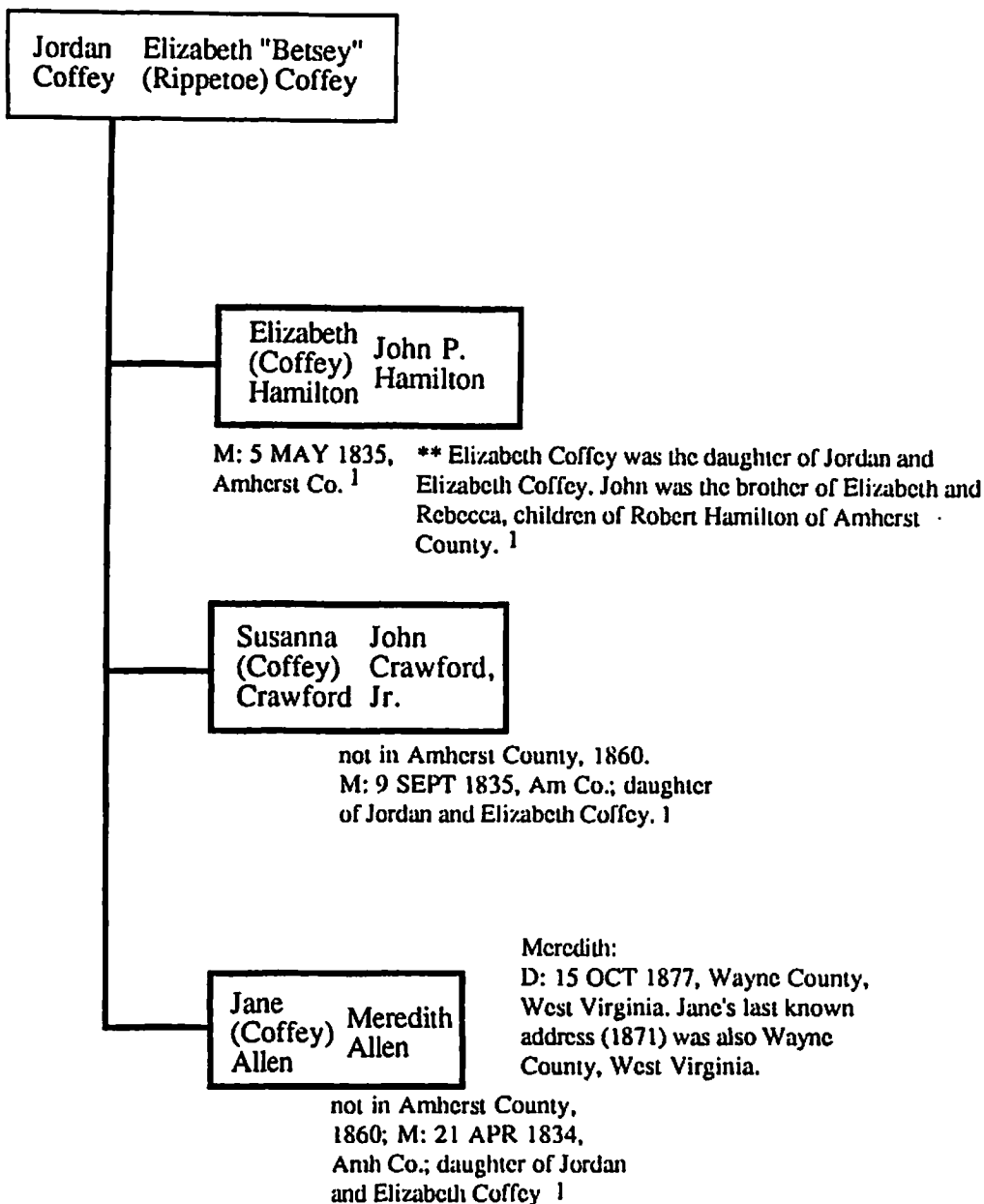

NOTES:

1. From Amherst County Marriage Records, State Archives
2. From "War of 1812: Virginia Bounty Land and Pension Applicants", 1987; State Archives.

**ORIGINAL
COFFEY
FAMILY IN
AMHERST
COUNTY**

Chart 4 of 4
JULY, 1992

**Hudson
"Huddie" and
Mahala
(Green)
(Lane)
Coffey**

HUDSON COFFEY

Hudson "Huddie" Coffey was the eldest son of Jordan and Elizabeth Rippetoe Coffey. He was born in 1804-1805, approximately two years after their marriage, in what is now Nelson County, probably along the Tye River in the general area of what is now Tyro, or more likely further east near the Piney Mountain and Ivy Creek.

Hudson deeded some of his property - a mare, bed and some furniture - to his father in 1827. This deed is listed in the Amherst County files, and is dated Dec. 31, 1827. This may have related to taxes, but the motive is not clear. Perhaps Hudson was simply devoted to his parents and wanted them to officially own something of his. It may have been compensation for Jordan's bringing his family to Amherst Co., as this is the earliest record found of Coffey family in present-day Amherst County. Jordan Coffey shows as the head of the household in the 1830, and 1840 Census Reports in Amherst County.

In the 1850 census report, where person's names are listed, Hudson is living with Jordan and Elizabeth in Amherst County. Within ten years, both his parents presumably died, as they do not show in any later census reports, and he was free to marry.

On 20 September 1855 Hudson married Mahala Lane, a widow. I don't know if there were any children by her first marriage, but census reports show a Joseph E. Coffey, presumably the son of Hudson and Mahala, living with the family in the Pedlar District of Amherst County. Joseph was 5 in 1860 and 16 in 1870 when the census was taken. Apparently Mahala was pregnant with Joseph at marriage or just after marriage. If she had other children, they were apparently too old to be living with the family in 1860. Perhaps Hudson continued living in his parent's house. His place of residence would be interesting to discover since it is likely that this is where Jordan and Elizabeth lived out the latter portion of their lives, and that this was the first Coffey dwelling in present day Amherst County.

Census reports show both Hudson and Mahala as illiterate. Nothing is known of his son, Joseph Coffey. Hudson is not listed in the Amherst County death records through 1896, and we don't have later census reports clear enough to establish his death date. He was 66 or 68 years old in 1870. Place of burial is unknown. He may be one of the early settlers of Coffeytown buried with only a boulder for his marker. Further research into deeds, etc. may turn up some information regarding his date of death.

(July, 1992)

Coffey Family History;
Original Coffey Settlers in "Coffeytown"
HUDSON COFFEY

Ca. 1780 *

Jordan Coffey	Elizabeth "Betsey" (Rippetoe) Coffey
------------------	---

Ca. 1805, Amherst Co., which included Nelson County *

Hudson "Huddie" Coffey	Mahala (Green) (Lane) Coffey
------------------------------	---------------------------------------

Joseph E. Coffey - Ca.1855 *

M: 20 SEPT 1855,
Amherst Co. His parents
were listed as Jordan and
Elizabeth Coffey.¹

Hudson was living with
Jordan and Betsey in
1850. Mahala was a
widow when they married.
No information on
whether there were
children by first marriage.

1. Amherst County Marriage records, State Archives.

* family listings this chart based primarily on 1840, 1850, 1860 Census Reports.
There were no Coffey family heads of households listed in present day Amherst County
in 1810 or 1820.

**HUDSON
"HUDDIE"
COFFEY
AND
FAMILY**

JULY, 1992

Please return any additions or corrections to John Taylor, 1417 Claremont Avenue; Richmond, VA 23227

**Schylar and
Elizabeth
"Betsey"
(Hamilton)
Coffey**

SCHYLAR COFFEY

Schylar may have been the second son of Jordan and Elizabeth Coffey, born around 1806. The marriage records do not list his parents, and death records have not been found for him. Schylar and Nelson are the only two of the original 9 for whom no specific listing of parentage has been found. Further, when Nelson married in 1833, Schylar gave permission, not Jordan and Elizabeth, although they were alive and living in Amherst County at the time.

The ancestry of Nelson and Schylar is not firmly established. Both of these names relate directly to Nelson County geography. Nelson was born approximately when a portion of Amherst became Nelson County. One district in Nelson County is Schuyler District. On occasions, Schylar's name has been written exactly that way. There were Coffeys who bought land at the northeast foot of the Piney Mountain in Nelson County, near Ivy Creek. Schuyler District dips down to this area and could well have been the source of Schylar's name. He and Nelson may be brothers, but only cousins to John Jack and Billy.

Schylar married Elizabeth Hamilton, daughter of Robert Hamilton, and sister of Rebecca Hamilton who married Nelson Coffey, on 30 January 1832. It seems Schylar and Elizabeth had 7 children (see chart). Sophia, Jordan, Schylar and perhaps John all married. No information regarding any of the older three has been found, although this George W. Coffey may have enlisted in the Nelson Artillery during the Civil War. If so, then he lived to be at least 74 years old. There were many George W. Coffey's around - in Rockbridge, Augusta, Nelson and Amherst, and the records are too unclear at this time to establish that this particular George did anything. All three, Frances, George and Robert, were still living with their parents in Amherst in 1860. Frances, 40 at the time, was still there in 1870. Jordan Coffey was in Company I of the 49th Virginia Infantry, CSA. No information on the others.

Schylar and his wife were alive in 1870. No death records were found for either of them. However it may be that Schylar, Jr.'s second wife died in August 1895 of fever, in Rockbridge County. Strangely, that person's name is listed as "Elizabeth, wife of Schylar Coffee". Perhaps the record is incorrect and the name should have been "Mary", since the person who died was 36 years old. Schylar, Sr.'s wife would have been 80-90 by this time, and it is unlikely that she would have had a 14 year old daughter. On 12 October 1895, their 14 year old daughter Anne Belle Coffee, also died of fever. If the record is correct, young Schylar must have taken on a third wife, shortly after his second marriage; or this is an entirely different Schylar.

(July, 1992)

Coffey Family History;
Original Coffey Settlers in "Coffeytown"
SCHYLAR COFFEY

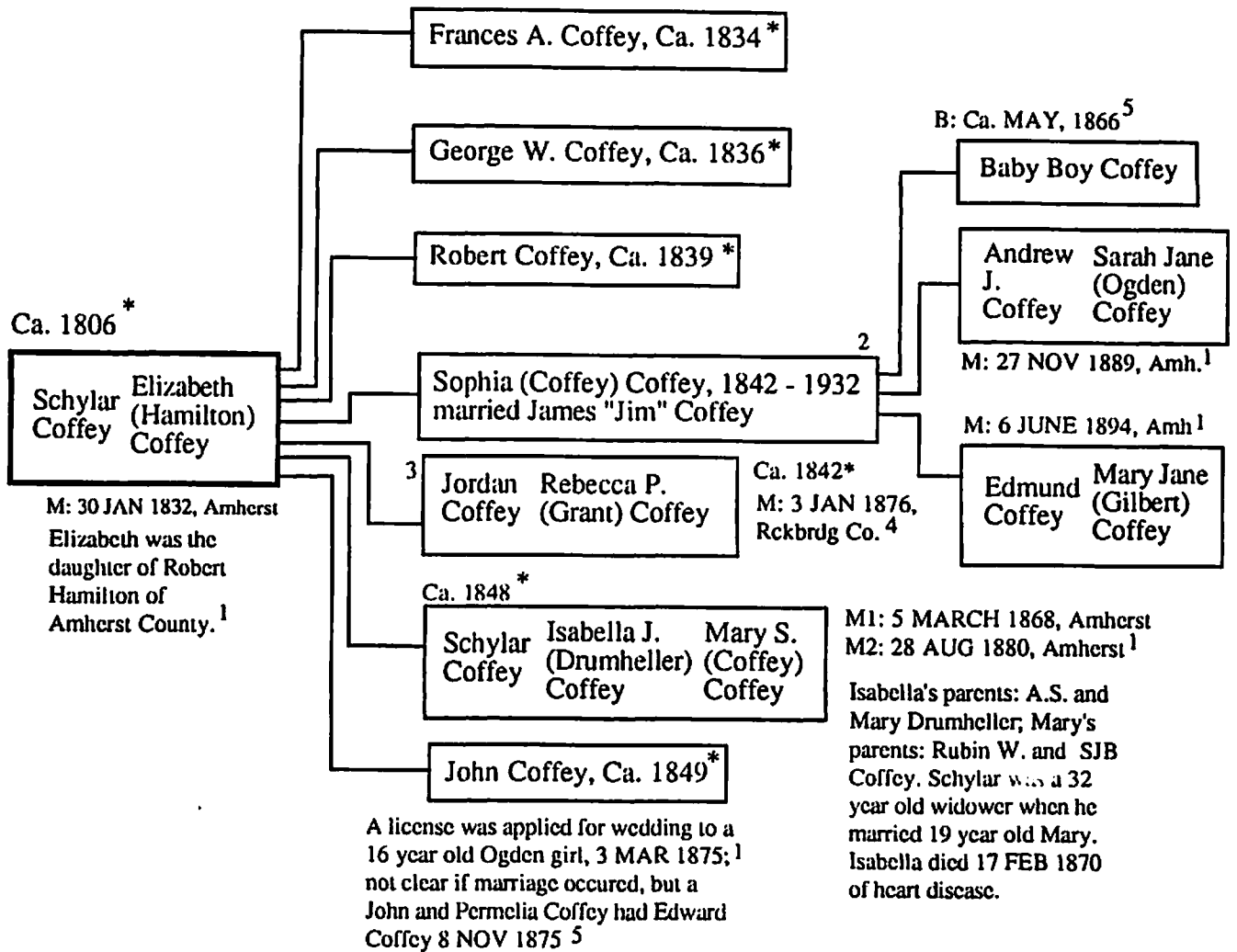

* family listings this chart based primarily on 1840, 1850, 1860 Census Reports.
There were no Coffey family heads of households listed in present day Amherst County
in 1810 or 1820.

1. From Amherst County Marriage Records at State Archives (1853 - 1935).
2. Buried in Bridgehill Cemetery at Coffeytown; dates from headstones.
3. Jordan enlisted in Co. "I", 49th Virginia Infantry, CSA, according to the Virginia
Regimental Histories Series.
4. Rockbridge County Marriage Records, State Archives
5. Statewide Birth Index

**SCHYLAR
COFFEY
AND
FAMILY**

JULY, 1992

Please return any additions or corrections to John Taylor, 1417 Claremont Avenue; Richmond, VA 23227

**John Jack
and
Elizabeth
"Betsey"
(Duff)
Coffey**

Coffey Family History;
Original Coffey Settlers in "Coffeytown"

JOHN JACK COFFEY

John Jack Coffey was born around 1809, according to the census reports. I have not found his death date in any of the official records. He was probably the third son of Jordan and Elizabeth Coffey.

On 18 January 1830, John Jack married Elizabeth "Betsey" (Duff) Coffey, the daughter of Joshua and Besley Duff of Fluvanna County. His parents were not listed in that document, but Jordan and Elizabeth were listed as witnesses. Census records imply that this couple had 7 children, including Mark Coffey who appears as a 10 year old only in the 1850 Census. He probably died between 1850 and 1860, but his death does not appear in the County Death Records. Another possibility is that William Henry, who was also 10 years old at the time and is not listed by name in this report, could have been nicknamed "Mark". Or William Henry and Mark could have traded parents for the summer, when the Census was taken, which was common practice in those days.

John Jack's sons Charles, John Jack, Jr., William Henry and Daniel Rufus all lived in Coffeytown proper and provided much of the population of the western and northern portion of Coffeytown. No record of marriage has been found for Mary Coffey, but Sarah Jane married William Davis in 1859. William Henry and Daniel Rufus married sisters in a double wedding on 6 April 1868. Charles, the eldest son, married Sarah Jane Ogden on Valentine's day, 1854. John Jack, Jr. married Patara Tyler, who was listed as a 24 year old "domestic" in Charles' household in the 1860 Census.

In August of 1871, Betsey died of Cholera. Henry Coffey, same generation as John Jack, died in June of the same year of Colic. About 1-1/2 years later, John Jack took a young wife, 25 year old Virginia C. Campbell of Rockbridge County. Apparently there were no children by the second marriage. In this marriage record, John Jack's parents are listed as J and E Coffey, most likely Jordan and Elizabeth. At the time, he was 64 years old.

I have no death record for him or any place of burial for either him or Betsey. They may be buried behind the Arthur Coffey house (Elsie Coffey's present house) in an unmarked grave.

(July, 1992)

**Coffey Family History;
Original Coffey Settlers in "Coffeytown"**

* listings are from 1840, 1850,
and 1860 Census reports and oral
history information; some dates
from headstones

* A 10 year old Mark Coffey
was listed in the 1850 Census,
same house with John Jack and
his family, no other mention in
public records.

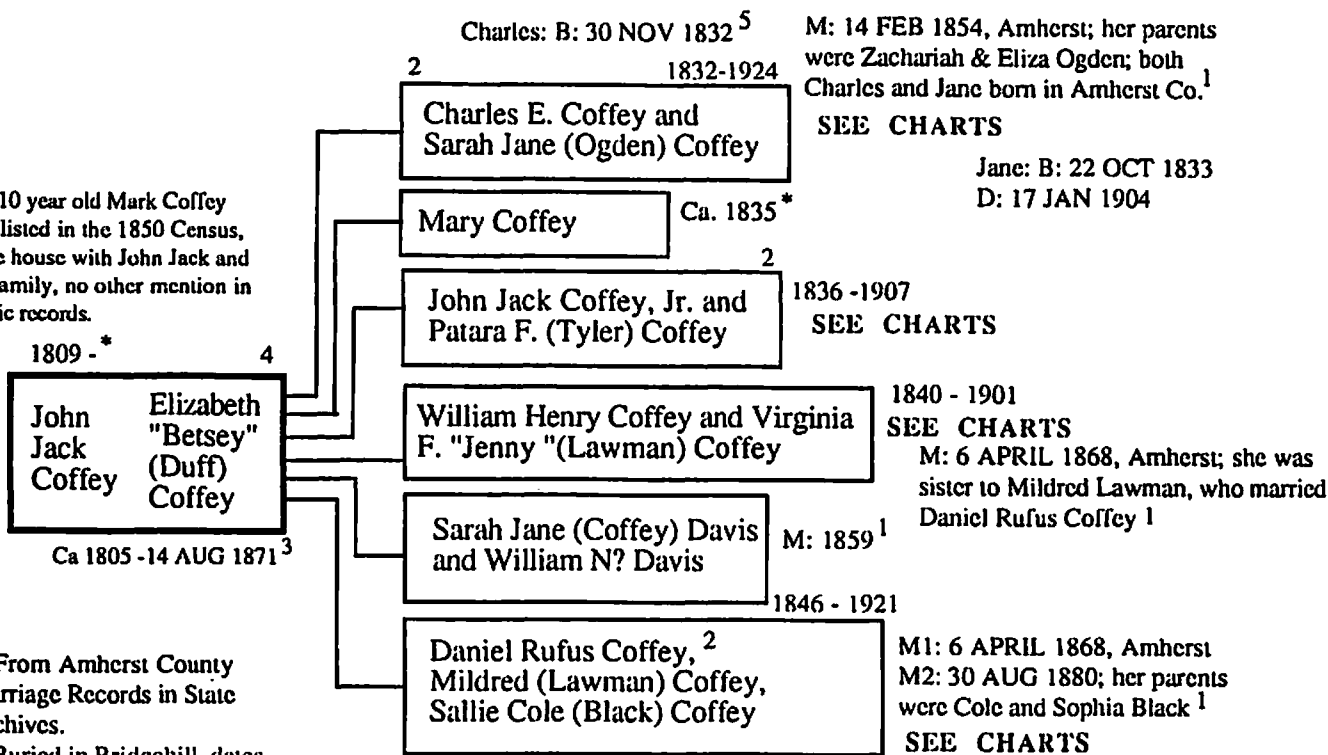

1. From Amherst County Marriage Records in State Archives.
2. Buried in Bridgehill, dates from headstones.
3. Am Co Death records, she died of Cholera, born in Fluvanna County to Joshua and Besley Duff.
4. On 1 APR 1873, John Jack married Virginia C. Campbell of Rockbridge County. He was 64, and the son of "J and E Coffey"; she was 25 years old. Apparently, there were no children by that marriage.
5. From Diane M. Gardner.

**JOHN JACK
COFFEY AND
FAMILY**

JULY, 1992

Please return all additions and corrections to John Taylor, 1417 Claremont Avenue; Richmond, VA 23227

**Coffey Family History;
JOHN JACK COFFEY**

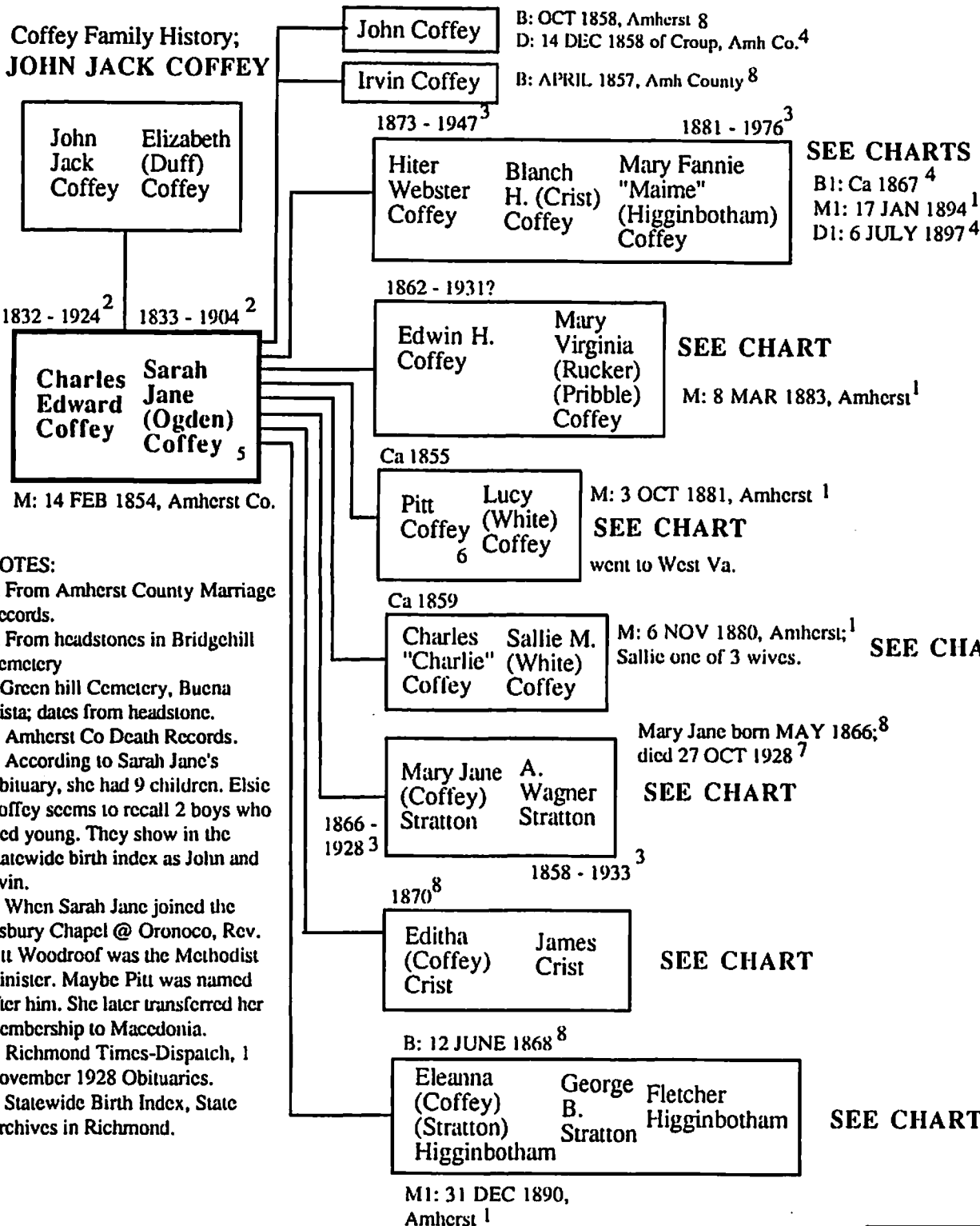

NOTES:

1. From Amherst County Marriage Records.
2. From headstones in Bridgehill Cemetery
3. Green hill Cemetery, Buena Vista; dates from headstone.
4. Amherst Co Death Records.
5. According to Sarah Jane's Obituary, she had 9 children. Elsie Coffey seems to recall 2 boys who died young. They show in the Statewide birth index as John and Irvin.
6. When Sarah Jane joined the Asbury Chapel @ Oronoco, Rev. Pitt Woodroof was the Methodist minister. Maybe Pitt was named after him. She later transferred her membership to Macedonia.
7. Richmond Times-Dispatch, 1 November 1928 Obituaries.
8. Statewide Birth Index, State Archives in Richmond.

**CHARLES
EDWARD
COFFEY**

**Coffey Family History;
Charles E. Coffey**

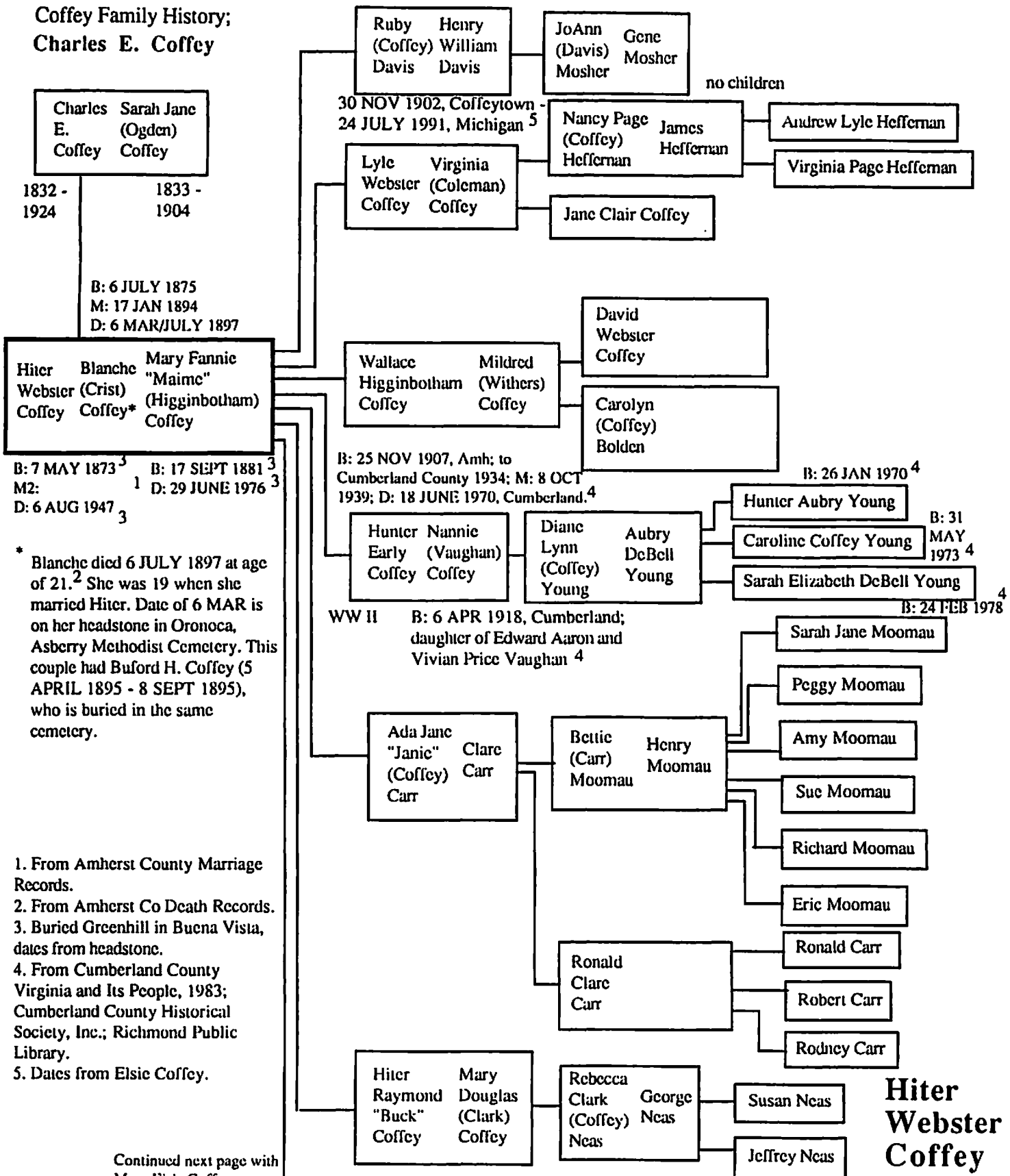

* Blanche died 6 JULY 1897 at age of 21.² She was 19 when she married Hiter. Date of 6 MAR is on her headstone in Oronoca, Asberry Methodist Cemetery. This couple had Buford H. Coffey (5 APRIL 1895 - 8 SEPT 1895), who is buried in the same cemetery.

1. From Amherst County Marriage Records.
2. From Amherst Co Death Records.
3. Buried Greenhill in Buena Vista, dates from headstone.
4. From Cumberland County Virginia and Its People, 1983; Cumberland County Historical Society, Inc.; Richmond Public Library.
5. Dates from Elsie Coffey.

Continued next page with Mary Elsie Coffey

Hiter Webster Coffey
 Chart 1 of 2

Coffey Family History;
Charles E. Coffey

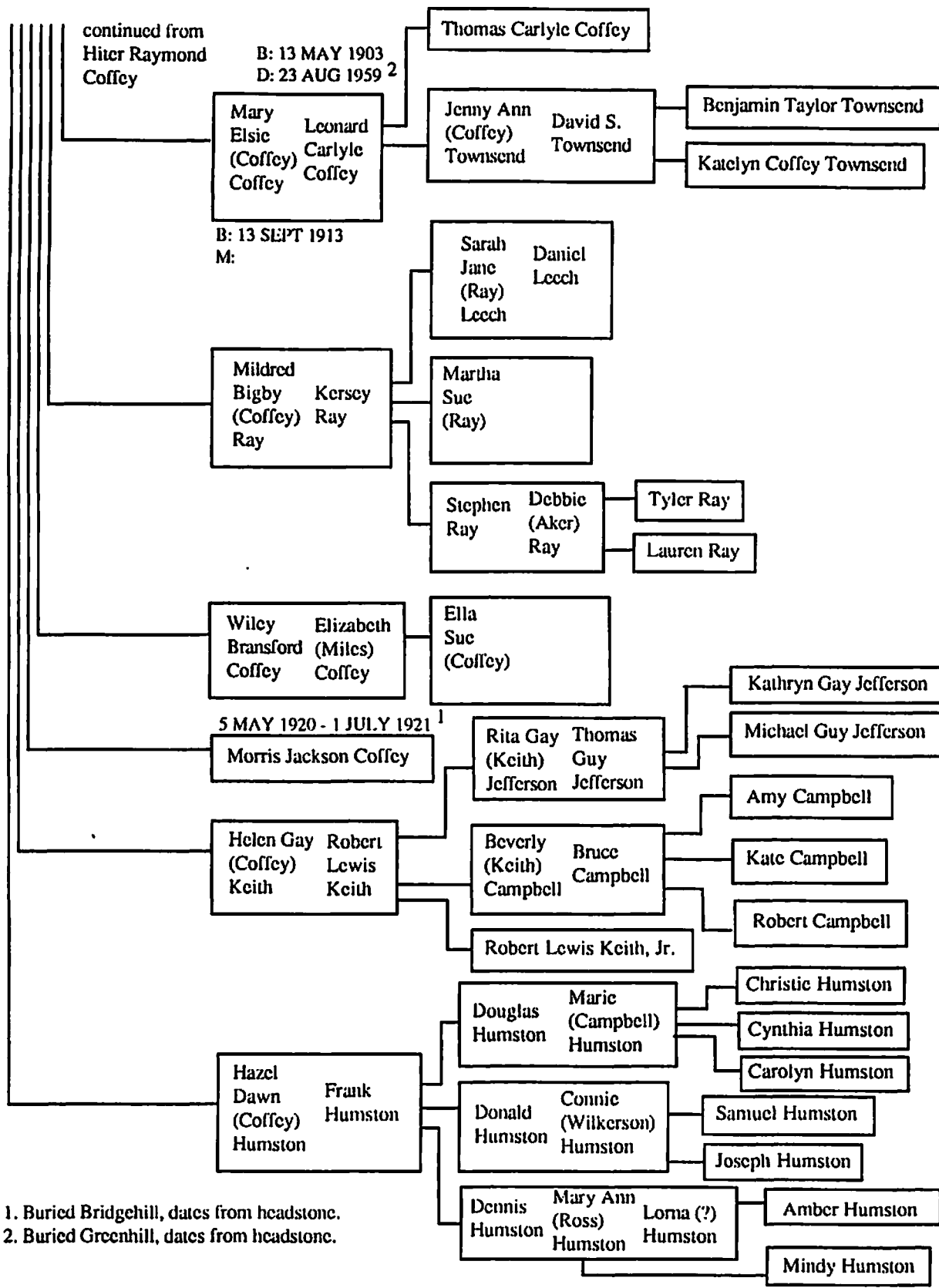

1. Buried Bridgehill, dates from headstone.
2. Buried Greenhill, dates from headstone.

Hiter
Webster
Coffey
Chart 2 of 2

**Coffey Family History;
Charles E. Coffey**

Charles E. Coffey
Sarah Jane (Ogden) Coffey

Edwin Horsley Coffey
Mary Virginia (Rucker) (Pribble) Coffey

B: Ca 1862²
M: 8 MAR 1883¹
D: Ca 1931²

This branch of the family lived in Tennessee.

1. From Amherst Co. Marriage Records.
2. All other info these charts is from a Coffey Family Tree by Donald Coffey and Ellen Wagner, obtained from Diane M. Gardner in July, 1992; unless footnotes indicate another source.

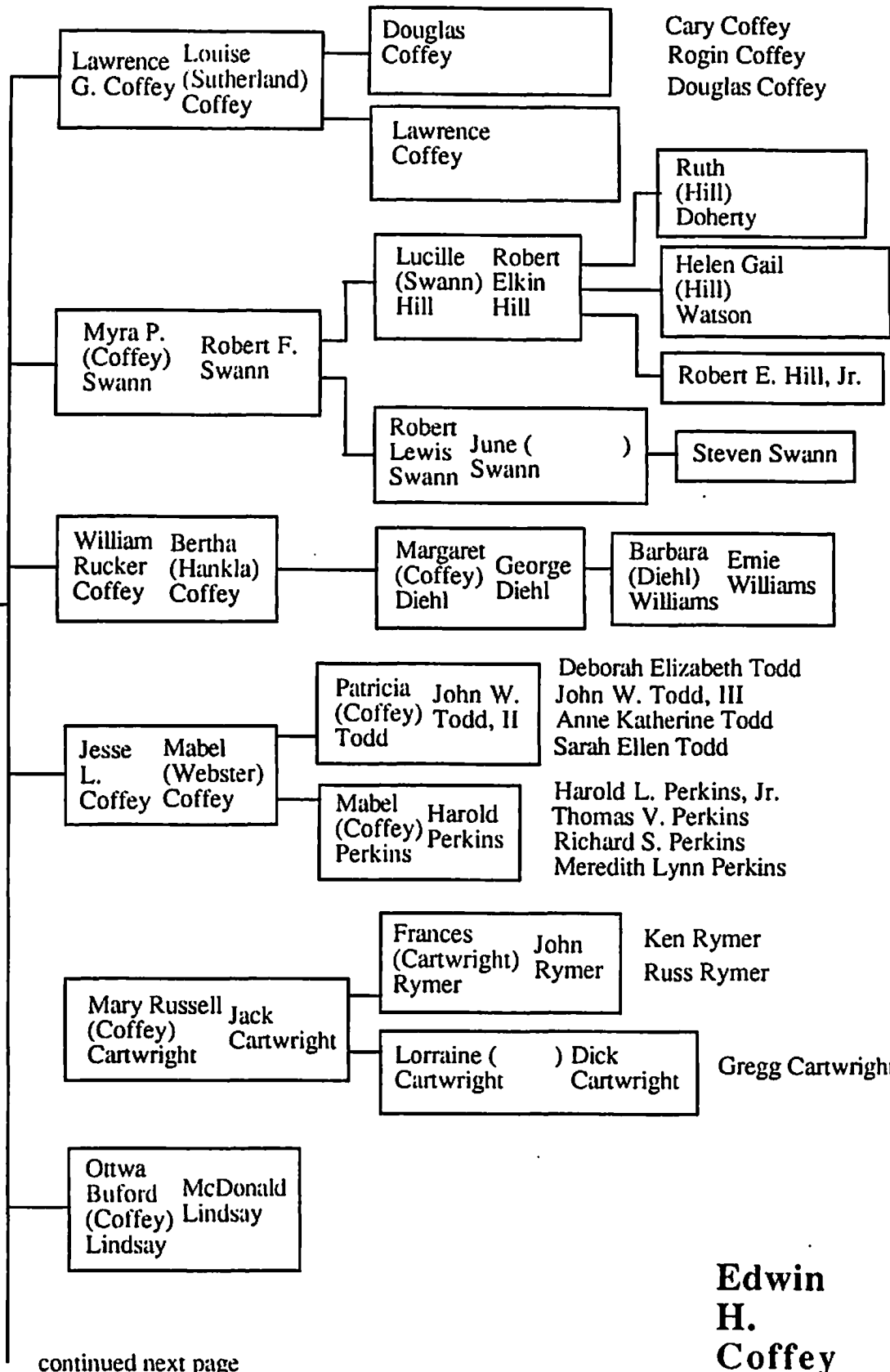

continued next page

**Edwin
H.
Coffey**

Chart 1 of 2

JULY, 1992

**Coffey Family History;
Charles E. Coffey**

continued from Ottwa Buford (Coffey) Lindsay

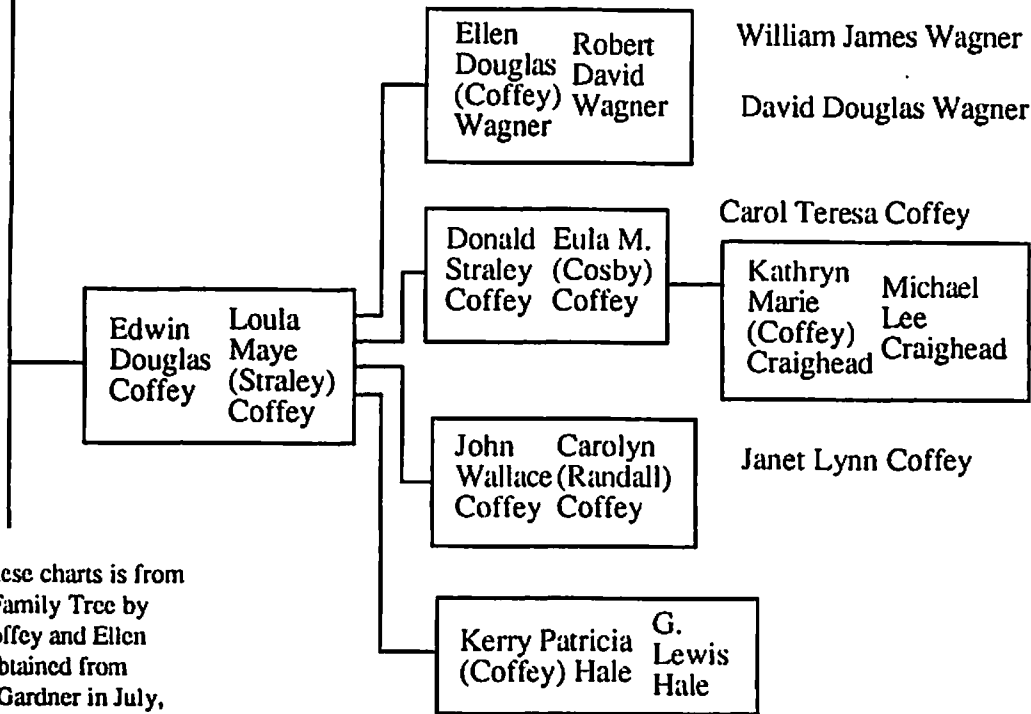

All info these charts is from a Coffey Family Tree by Donald Coffey and Ellen Wagner, obtained from Diane M. Gardner in July, 1992; unless footnotes indicate another source.

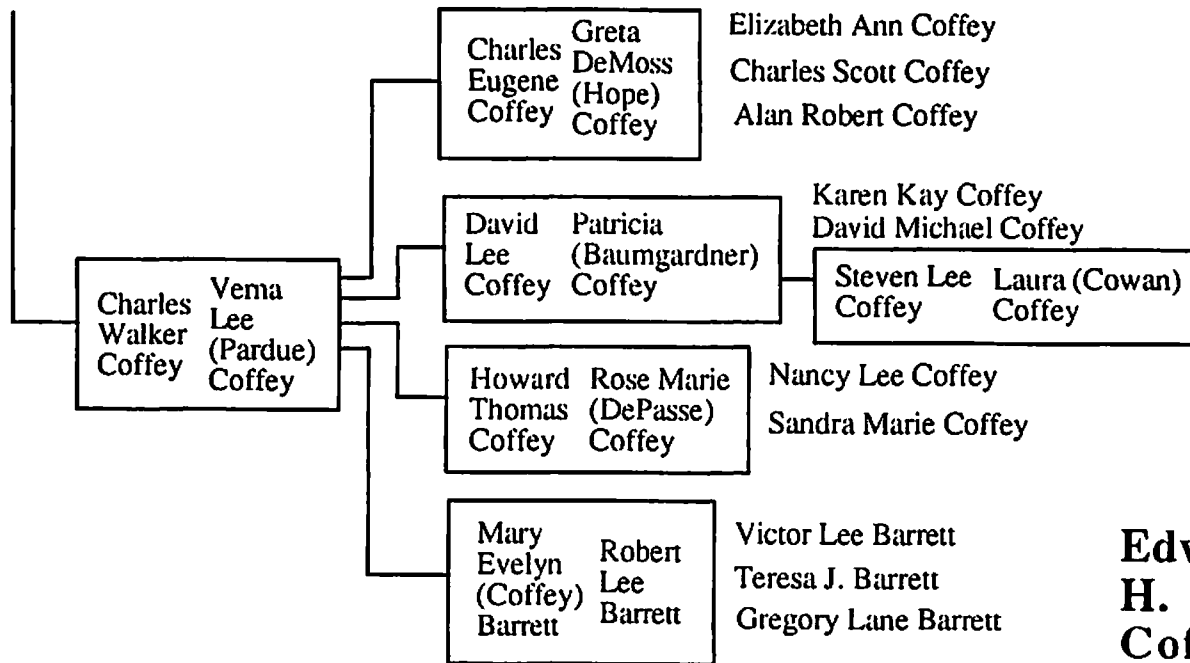

**Edwin
H.
Coffey**

Chart 2 of 2

JULY, 1992

Please return all additions and corrections to John Taylor; 1417 Claremont Avenue; Richmond, VA 23227

Coffey Family History;
Charles E. Coffey

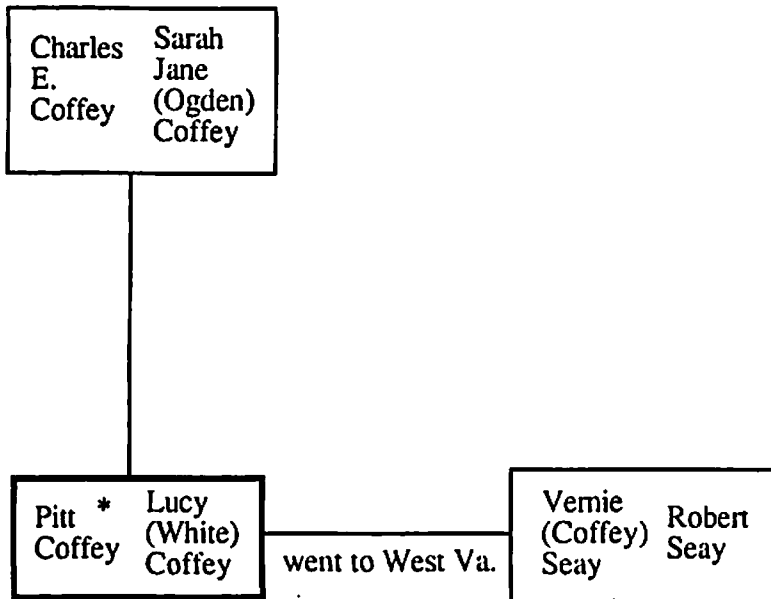

B: Ca 1855
M: 3 OCT 1881, Amherst¹
D:

* Pitt was possibly named after Rev. Pitt Woodroof, a local Methodist minister. Pitt's mother Sarah Jane Coffey joined the Ashbury Chapel at Oronoco, and later joined the Macedonia Church. Rev. Woodroof was her first minister.

Not long after his marriage to Lucy, Pitt ran off to West Virginia with his mistress Flovonnice Fletcher, leaving his wife and child.

No attempt has been made to track his life in West Virginia.

1. Amherst County Marriage Records. Pitt was a 26 year old widower when he married 18 year old Lucy. She was a widow at 18

**Pitt
Coffey**

Chart 1 of 1

JULY, 1992

Please return all additions and corrections to John Taylor, 1417 Claremont Avenue, Richmond, VA 23227

**Coffey Family History;
Charles E. Coffey**

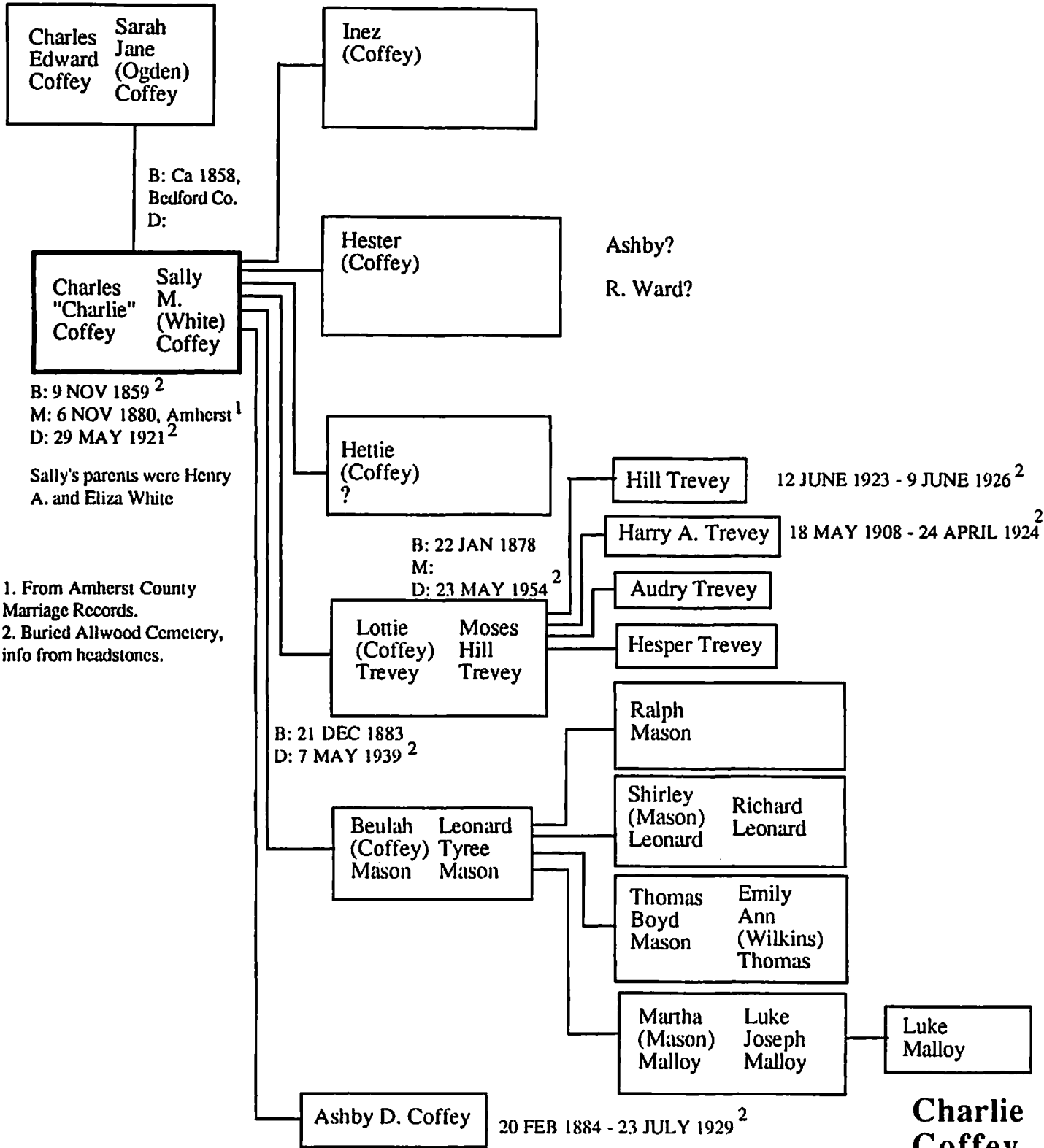

1. From Amherst County Marriage Records.
 2. Buried Allwood Cemetery, info from headstones.

Charlie Coffey

Chart 1 of 1
 MAY, 1991

Please return all additions and corrections to John Taylor, 1417 Claremont Avenue; Richmond VA 23227

**Coffey Family History;
Charles E. Coffey**

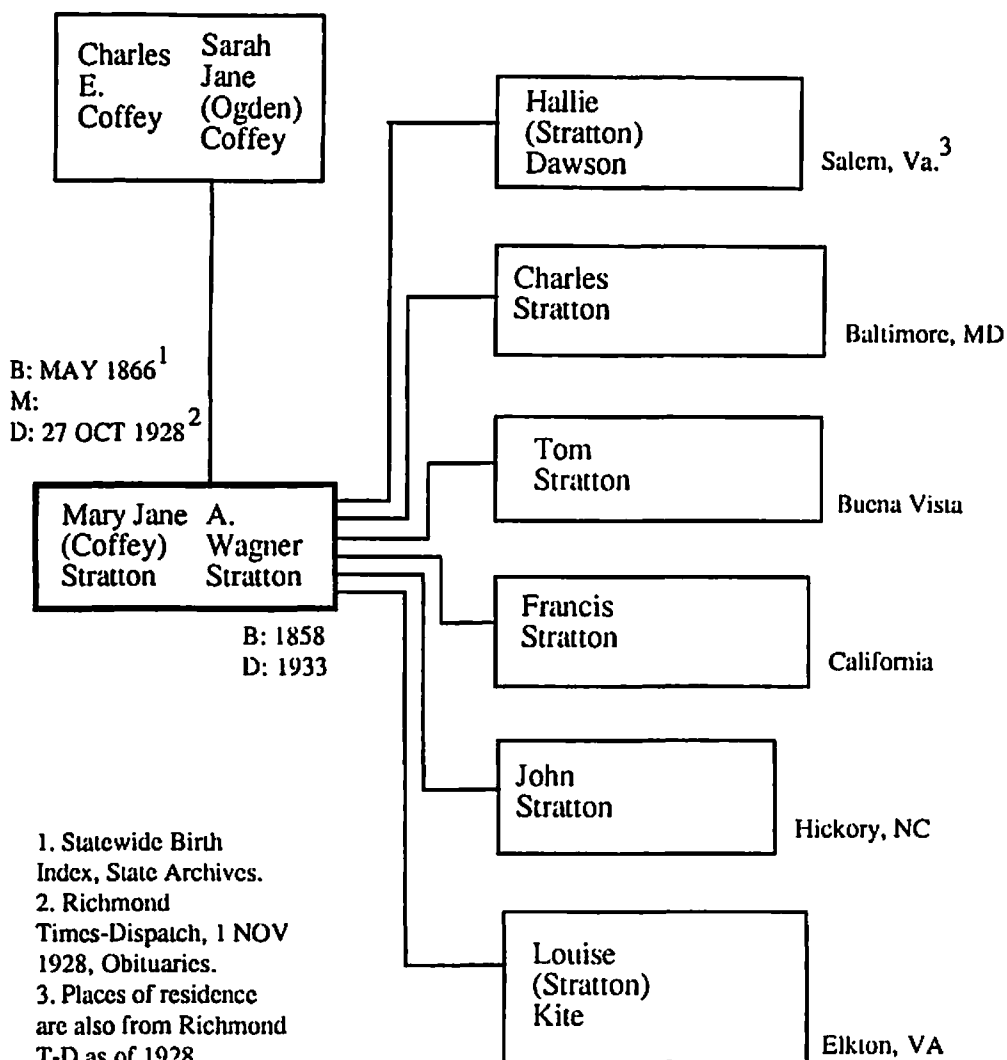

1. Statewide Birth Index, State Archives.
2. Richmond Times-Dispatch, 1 NOV 1928, Obituaries.
3. Places of residence are also from Richmond T-D as of 1928.

**Mary Jane
(Coffey)
Stratton**

Chart 1 of 1

Please return all additions and corrections to John Taylor; 1417 Claremont Avenue; Richmond, VA 23227

JULY, 1992

Coffey Family History;
Charles E. Coffey

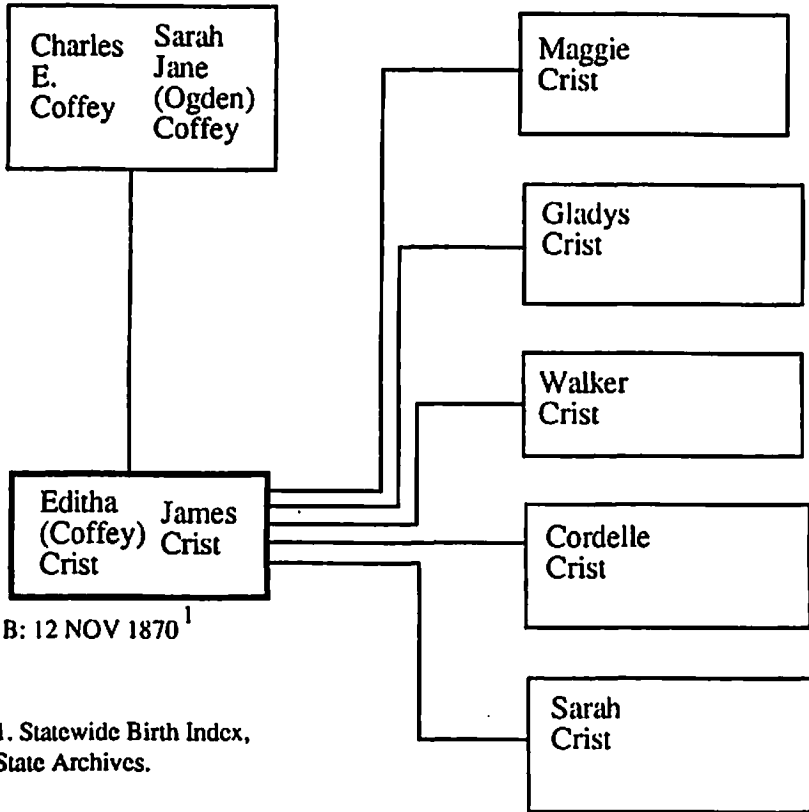

**Editha
(Coffey)
Crist**

Chart 1 of 1
JULY, 1992

Coffey Family History;
Charles E. Coffey

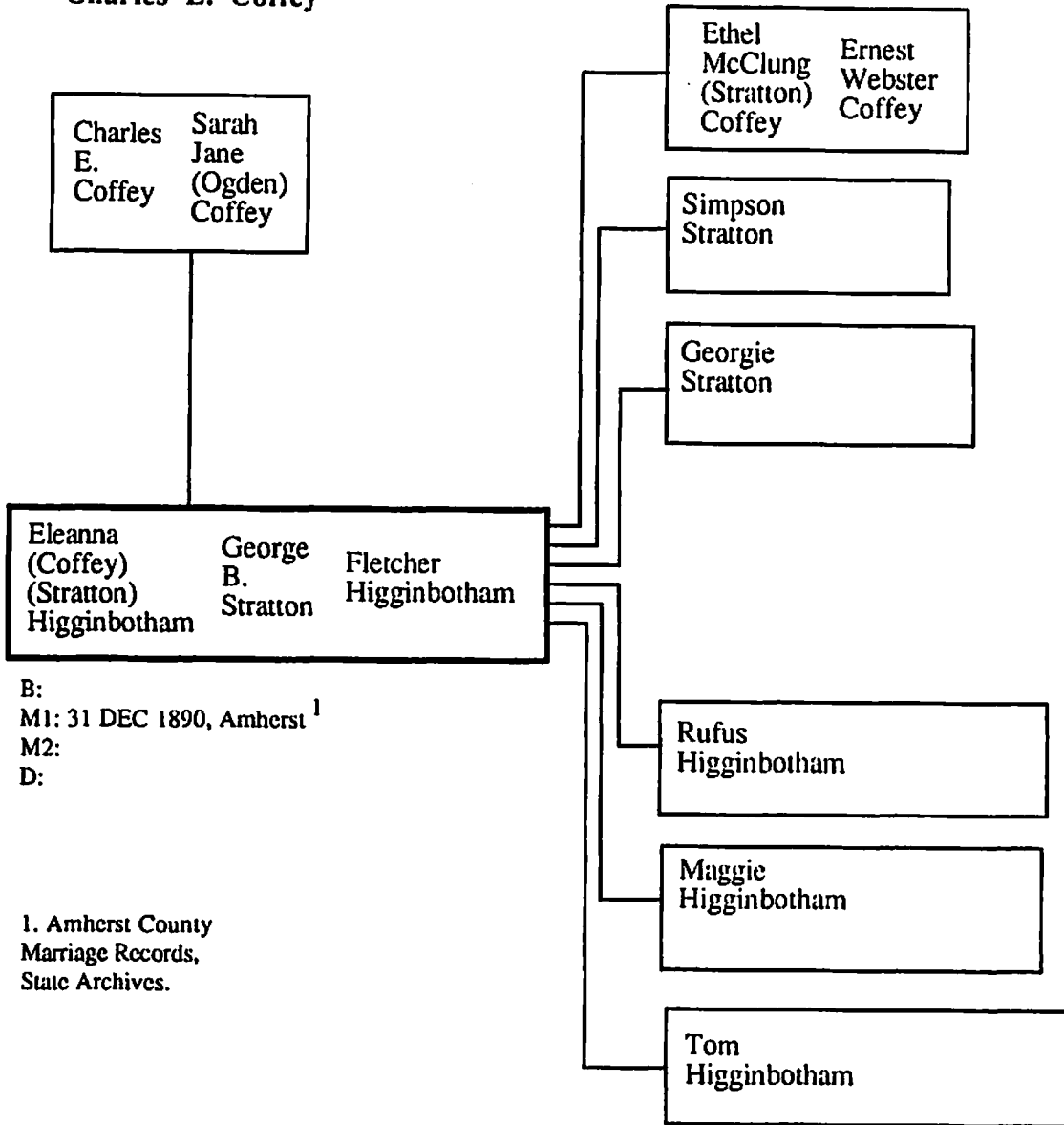

1. Amherst County
Marriage Records,
State Archives.

**Eleanna
(Coffey)
(Stratton)
Higginbotham**

Chart 1 of 1

Please return all additions and corrections to John Taylor, 1417 Claremont Avenue, Richmond, VA 23227

JULY, 1992

**Coffey Family History;
JOHN JACK COFFEY**

John Elizabeth
Jack "Betsy"
Coffey (Duff)
Coffey

B: 5 NOV 1838
D: 8 MAR 1921¹

John Patara F.
Jack (Tyler)
Coffey, Coffey
Jr.

B: 8 MAY 1836
M:
D: 1 DEC 1907¹

B: 1862
M: 13 FEB 1883, AMH Co.²

Marcia Joseph
"Molly" (Coffey) Dodd
Dodd

Lyle Dodd
Myra Dodd
Atwell Dodd
Dewey Dodd
Ward Dodd

Henley Avarilla
Coffey (Ogden)
Coffey

Henley:
1863 - 1927
M: 14 OCT 1886; her parents:
Zachariah and M.E. Ogden²

Sherer Coffey
Samuel Coffey
Kinckle Coffey
Harry Coffey
Edgar Coffey
Bentley Coffey
Ethel Coffey

B: 1866³

Lena Pet
(Coffey) Campbell⁵

Herman Campbell
Hardy Campbell
Lottie Campbell
Ollie Campbell
Myrtle Campbell
Elizabeth "Lizzie" Campbell

B: 11 MAY 1868⁶
M: 8 DEC 1886, AMH Co.²
D: 22 APR 1910, Bridgehill.³

Emma Jane Howard D.
(Coffey) "Jack"
Campbell Campbell⁵

Bernard Campbell
Buford Campbell
Letcher Campbell
Leonard Campbell
Charles Campbell

B: 22 JUNE 1870
M:
D: 21 NOV 1933; El
Bethel Church, Allwood³
Mattie:
B: 18 APR 1879
D: 18 MAY 1949³

John E. Mattie
Coffey (Dodd)
Coffey

Earl Coffey
Robert Coffey (1908 - 1951)
Page Coffey married Corrine Sales

Lutia V. Charles
(Coffey) D. Gilbert⁴
Gilbert Gilbert⁴

Lutia:
B: 15 SEPT 1873
M: 16 OCT 1895, Amh Co.²
D: 26 MAR 1906³

Era Gilbert
John Gilbert
Gracie Gilbert

1875 - 1926³ 1869 - 1954³

Elizabeth Charles
"Lizzie" D. Gilbert⁴
(Coffey) Gilbert

Mary Gilbert
Charles H. Gilbert married Nancy Gilbert

1879 - 1963 1886 - 1954

Ambrose Mattie Miles
Rucker (Higginbotham)
Coffey Coffey

SEE CHARTS

Mary Coffey died as infant³

Jane Coffey died as infant³

**JOHN
JACK
COFFEY,
JR.**

NOTES:

1. Buried in Bridgehill Cemetery, dates from headstone.
2. Amherst County Marriage Records, Va. State Archives.
3. Information from Morris Coffey.
4. Charles married Lutia first, who died in childbirth with twins. The twins are buried behind Page Coffey's home on Route 60. Elizabeth, Lutia's sister, was his second wife.
5. Pet Campbell and "Jack" Campbell were brothers.
6. Statewide Birth Index, State Archives.

**Coffey Family History;
John Jack Coffey, Jr.**

John Jack Coffey, Jr. Patara F. (Tyler) Coffey

8 MAY 1836 - 1 DEC 1907 5 NOV 1838 - 8 MAR 1921 ¹

Ellena (Coffey) Campbell Howard Donald "Jack" Campbell

ELLENA:
B: 12 JULY 1866, Amherst
M: 8 DEC 1886, Amherst
D: 22 MARCH 1950,
Roanoke, Va.; buried
Sherwood Cemetery

HOWARD:
B: 30 JUNE 1867, Rockbridge
D: 4 NOV 1951, Sherwood
Cemetery

NOTES:

1. Dates from Headstones, both buried in Bridgehill Cemetery, Coffeytown. Death date coincides with Family Bible date, according to Rita Parrish, Dallas, TX.

2. Unless noted otherwise, all information this chart was furnished by Rita Parrish of Dallas, TX

Ollie Aurelia (Campbell) Williams Oscar David Williams

B: 31 OCT 1887,
Rockbridge County
M: 21 SEPT 1918
D: 24 AUG 1957,
Smyth County, Va.

Lottie Virginia (Campbell) Fauber Henry Franklin Fauber

B: 16 MARCH 1889
M: 30 JUNE 1915

Herman Howard Campbell

B: 10 JULY 1891
D: JAN 1977

B: 14 DEC 1893
M: 19 MAY 1912

Mertie Loving (Campbell) Harvey W. T. Harvey

Elizabeth Bryant (Campbell) Gregory Edgar Gregory

B: 2 JULY 1896
M: 21 MAY 1925
D: 27 MARCH 1969

Hardy Thomas Campbell

B: 17 JULY 1898

Emily Shelby (Williams) Lloyd Ward Lee Lloyd

B: 21 JUNE 1909, Atkins, VA
M: 8 JAN 1944

Margie Ellena (Williams) Perkins Herbert Hoover Perkins

B: 16 JUNE 1921; M: 28 APRIL 1941

Freeman Marco (Williams) Vance Margaret (McKee) Williams

B: 3 MARCH 1923; M: 24 DEC 1949

Donald Sylva (Campbell) Williams Lyndsy Williams

B: 12 DEC 1942; M: 2 NOV 1948

Jessie Oscar (Williams) Williams Geraldine (Conti) Williams

B: 24 SEPT 1926; M: 2 JULY 1948

Lois Aurelia (Williams) Richardson Rudolph Richardson

B: 27 MARCH 1929; M: 2 JULY 1950

Rita Jean (Lloyd) Parrish Eugene Walter Parrish III *

B: 14 DEC 1944; Marion, VA
M: 15 MAR 1972, Dallas, TX

* Rita and Eugene have two children: EUGENE "WALT" PARRISH, IV (B: 30 AUG 1975, Dallas) and ZACHARY SHELBY PARRISH (B: 2 JUNE 1978)

Ellena (Coffey) Campbell

JANUARY, 1993

**Coffey Family History;
John Jack Coffey, Jr.**

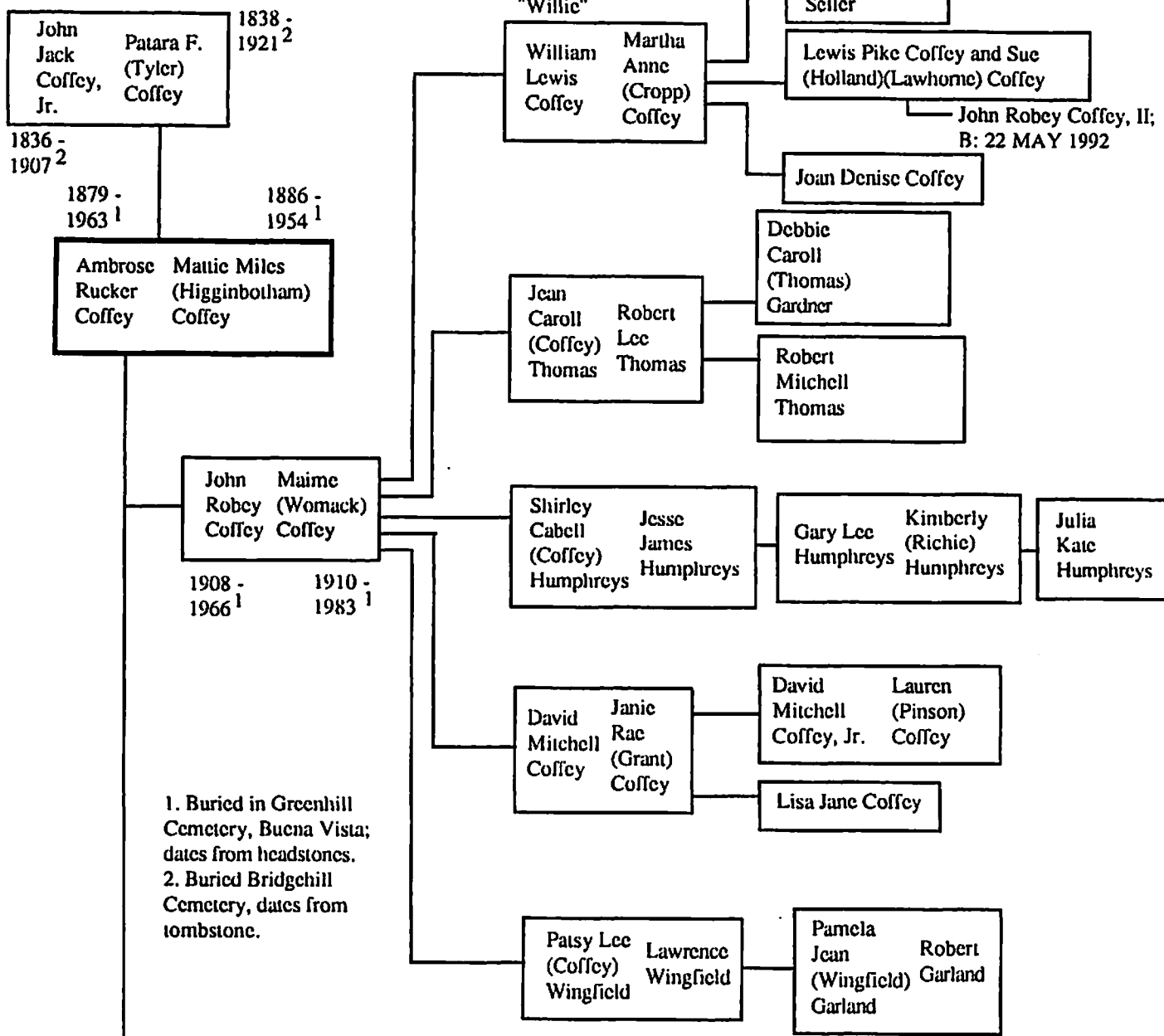

1. Buried in Greenhill Cemetery, Buena Vista; dates from headstones.
2. Buried Bridgehill Cemetery, dates from tombstone.

continued next page with Wendell Holmes Coffey

Ambrose Rucker Coffey

Chart 1 of 2
JULY, 1992

**Coffey Family History;
John Jack Coffey, Jr.**

NOTES:

1. Sister to Embree Crawford.
2. Owned original John Jack's house until 1988.
3. Lived in Norfolk, owned and operated Nursing Home; buried Greenhill.

continued from John Robey Coffey

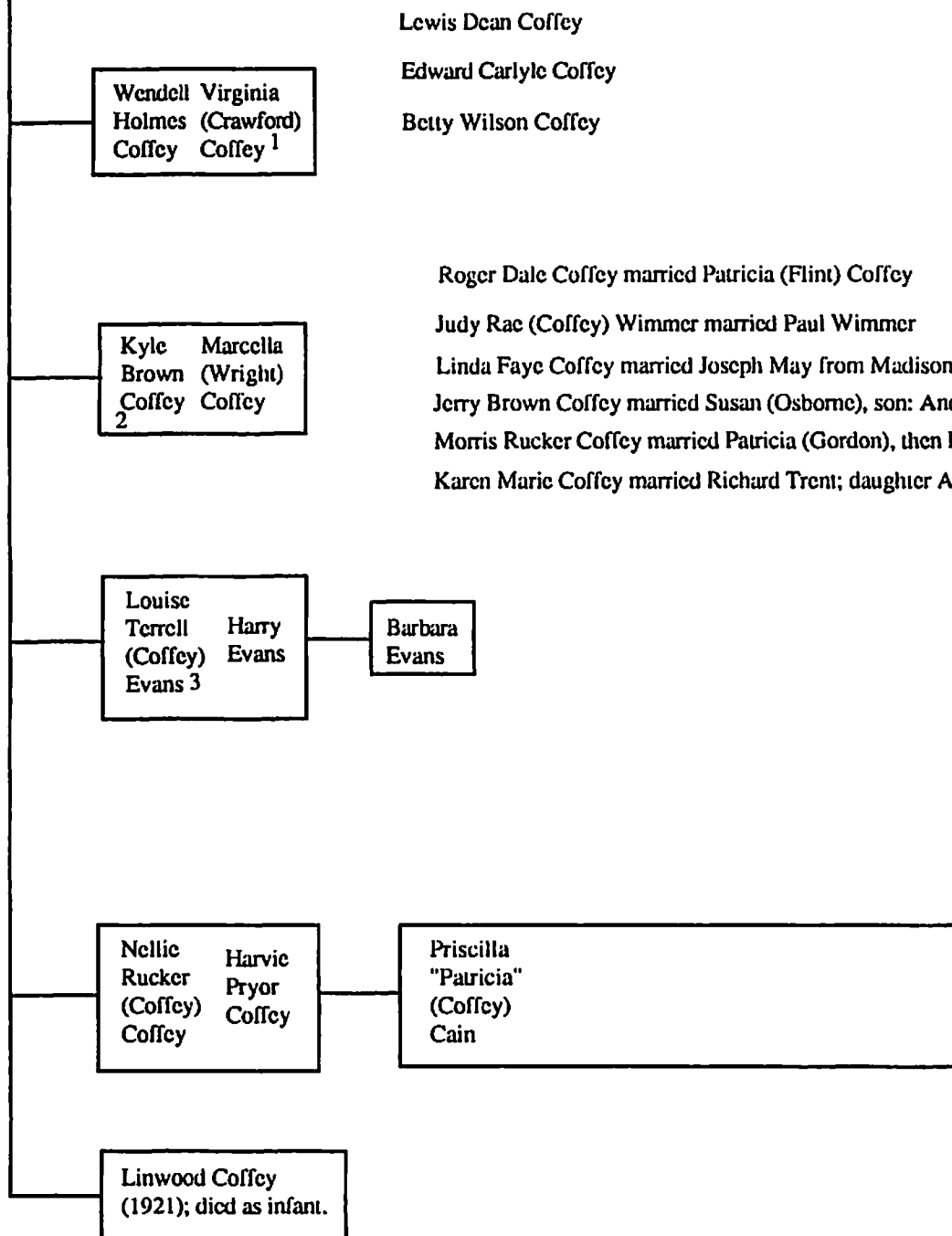

Lewis Dean Coffey

Edward Carlyle Coffey

Betty Wilson Coffey

Roger Dale Coffey married Patricia (Flint) Coffey

Judy Rac (Coffey) Wimmer married Paul Wimmer

Linda Faye Coffey married Joseph May from Madison Heights

Jerry Brown Coffey married Susan (Osborne), son: Andrew Coffey

Morris Rucker Coffey married Patricia (Gordon), then Linda (Lawhome)(Tyler) Coffey

Karen Marie Coffey married Richard Trent; daughter Amy Marcella Coffey

**Ambrose
Rucker
Coffey**

Chart 2 of 2

**Coffey Family History;
John Jack Coffey**

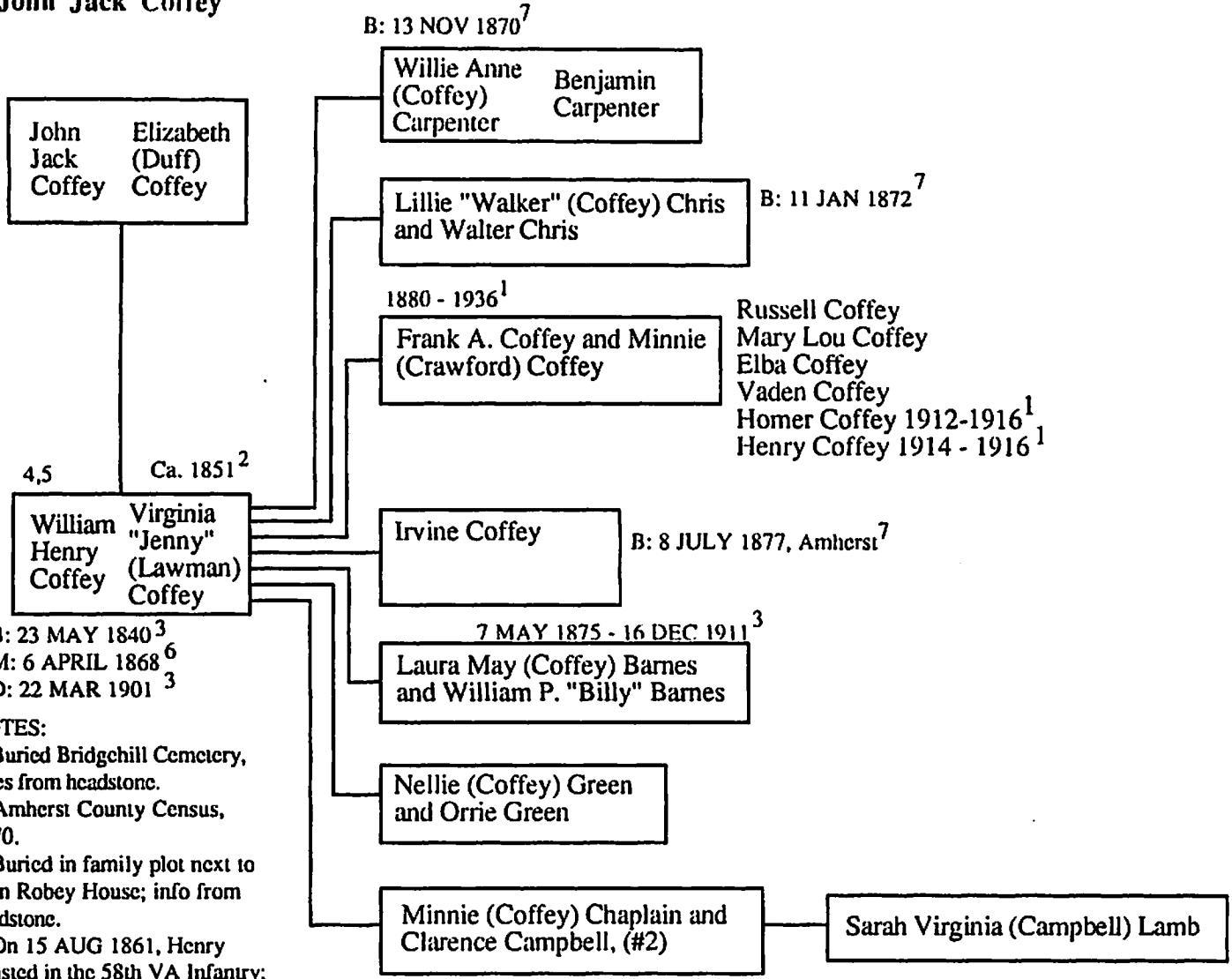

NOTES:

1. Buried Bridgehill Cemetery, dates from headstone.
2. Amherst County Census, 1870.
3. Buried in family plot next to John Robey House; info from headstone.
4. On 15 AUG 1861, Henry enlisted in the 58th VA Infantry; he was captured at Spotsylvania CH on 12 MAY 1864 and sent to FT. Delaware. He was released 19 JUNE 1865. Henry was 5'-6" tall, he had dark hair, dark eyes, and dark complexion. (From the Virginia Regimental Histories Series, Best Seller book store, Lexington.)
5. Nicknamed "Cripple Henry", Wm H. was wounded as a Confederate soldier in the Civil War.
6. Amherst County Marriage Records.
7. Statewide Birth Index, State Archives.

**WILLIAM
HENRY
COFFEY**

JULY, 1992

Please return all additions and corrections to John Taylor, 1417 Claremont Avenue; Richmond, VA 23227

**Coffey Family History;
JOHN JACK COFFEY**

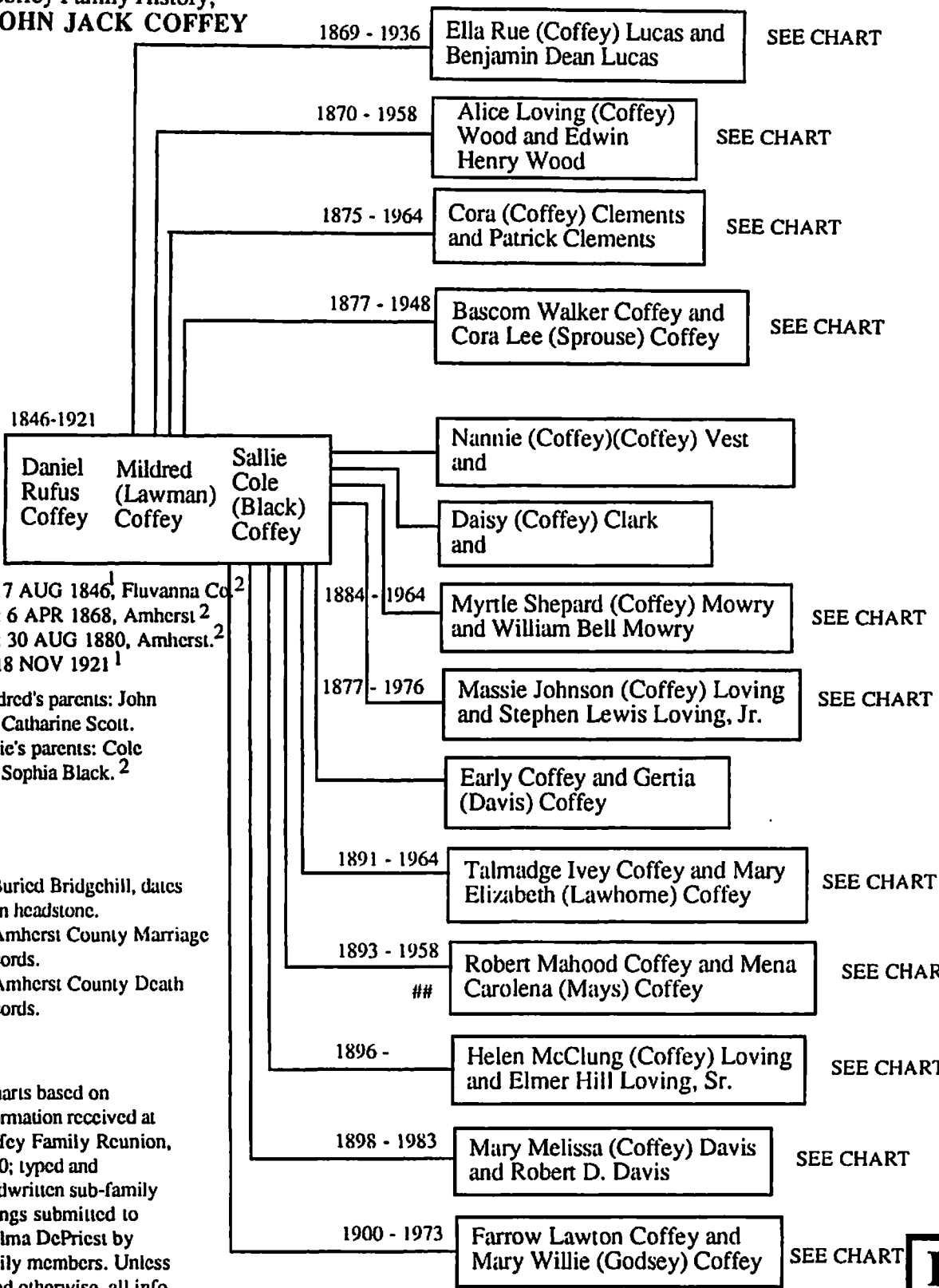

B: 17 AUG 1846, Fluvanna Co.¹
M1: 6 APR 1868, Amherst²
M2: 30 AUG 1880, Amherst.²
D: 18 NOV 1921¹

Mildred's parents: John and Catharine Scott.
Sallie's parents: Cole and Sophia Black.²

- 1. Buried Bridgehill, dates from headstone.
- 2. Amherst County Marriage Records.
- 3. Amherst County Death Records.

*Charts based on information received at Coffey Family Reunion, 1990; typed and handwritten sub-family listings submitted to Thelma DePriest by family members. Unless noted otherwise, all info is from that source.

##: Amherst County Death Records show a "Rob Coffey", son of Daniel and Sallie, died at 4 months old on 12-22-1894.

**DANIEL
RUFUS
COFFEY**

Please return all additions and corrections to John Taylor, 1417 Claremont Avenue; Richmond, VA 23227

JULY, 1992

**Coffey Family History;
Daniel Rufus Coffey**

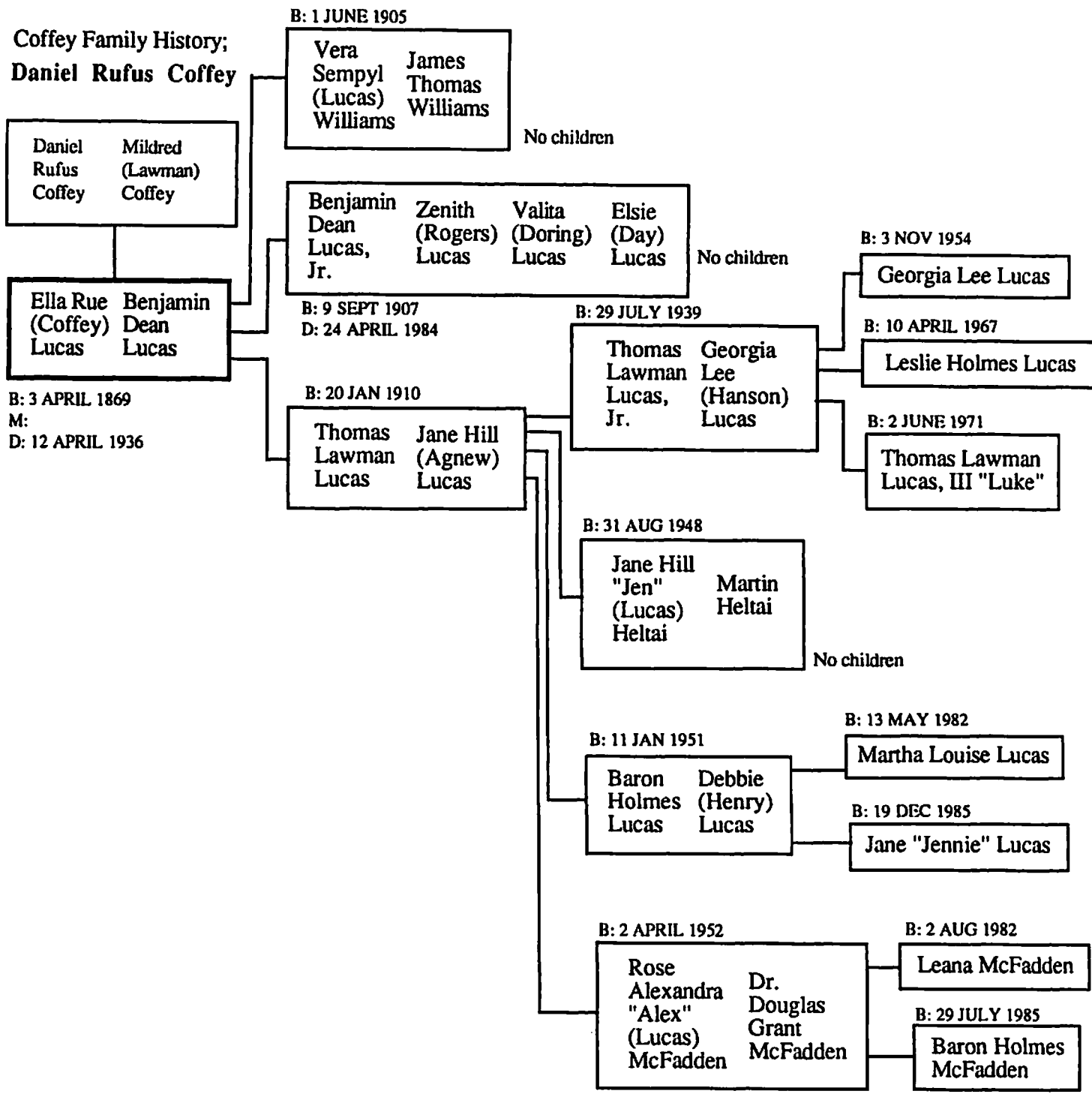

**Ella Rue
(Coffey)
Lucas**

Chart 1 of 1

Please return all corrections and additions to John Taylor, 1417 Claremont Avenue; Richmond, VA 23227

AUGUST, 1990

**Coffey Family History;
Daniel Rufus Coffey**

continued from
first page

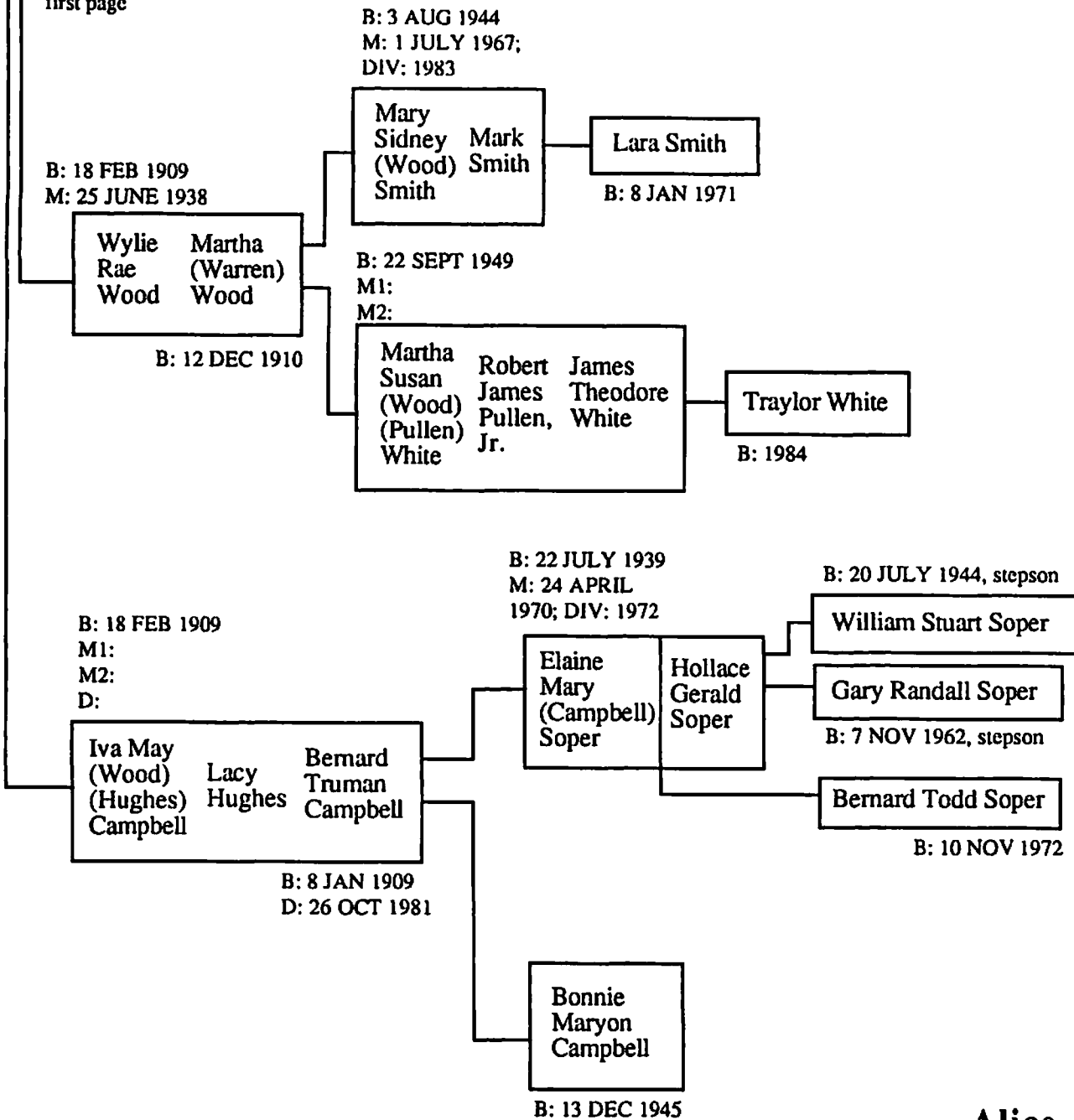

**Alice
Loving
(Coffey)
Wood**

Chart 2 of 2
AUGUST, 1991

Please return all additions and corrections to John Taylor; 1417 Claremont Avenue, Richmond, VA 23227

**Coffey Family History;
Daniel Rufus Coffey**

B: 26 OCT 1900
D: 2 SEPT 1930

Daniel Mildred
Rufus (Lawman)
Coffey Coffey

Lile Goldie
Bascom (McKinley)
Clements Clements

B: 8 MAY 1875
D: 8 FEB 1964

Cora Lee Rev Patrick
(Coffey) Henry
Clements Clements

B: 9 OCT 1867
D: 29 SEPT 1950

B: 26 JULY 1903
D:

Louise Terrell Judge
(Clements) J.H. Cole
Cole

B: 12 NOV 1926
D:

Harriet Louise W. J.
(Cole) Mayes Mayes

Died 1969

B: 16 OCT 1953

W. J. Mayes, III

Clements
Cole Mayes

B: 15 AUG 1958

B: 14 JULY 1934
D:

Nancy Clements Cole

Barbara Ann J. B.
(Cole) Jacks Jacks

B: 20 MAY 1940
D:

Bernard Paul Jacks

B: 21 MAR 1967

* Information from Mrs.
Joyce Mason, August, 1991

**Cora Lee
(Coffey)
Clements**

Chart 1 of 1
August, 1991

Please return all corrections and additions to John Taylor, 1417 Claremont Avenue; Richmond, VA 23227

**Coffey Family History;
Daniel Rufus Coffey**

B: 3 JAN 1906 B: 11 ? 1908
D: 24 MAR 1973 D: 30 MAR 1982

Daniel Mildred
Rufus (Lawman)
Coffey Coffey

B: 24 FEB 1881
D: 4 NOV 1966

Bascom Cora Lee
Walker (Sprouse)
Coffey Coffey

B: 15 JULY 1877
M: 28 AUG 1902
D: 24 MAR 1948

Chambers Lucille
Ray (Montgomery)
Coffey Coffey

2 sons, 1 daughter

B: 28 FEB 1908 B: 10 MAR 1917
D: 26 MAR 1983 D:

Lloyd Zola
Douglas (Holland)
Coffey Coffey

No Children

B: 20 JULY 1910 B: 5 JULY 1915
D: 23 JULY 1991 D:

James Ola
Cecil (Crowder)
Coffey Coffey

Jolene Coffey, lives in Georgia
Sandra Coffey, lives in Norfolk

B: 18 FEB 1913
M1: B: 30 AUG 1907 B: 11 APR 1910
M2: D: 2 OCT 1959 D: 22 APR 1982

Annie Mildred
(Coffey) Otho Clyde
(Crowder) Crowder Fisher
Fisher

2 sons, 6 stepchildren

B: 17 FEB 1916

Alfred Mary
Rufus (Lane)
Coffey Coffey

4 sons, 6 daughters

B: 28 MAR 1919 B: 7 JULY 1915

Evelyn Marie
Hunter
(Coffey) Allen
Allen

5 sons, 1 daughter

B: 14 JULY 1922 B: 13 SEPT 1929
D: 3 MAY 1986

Lester Edith
Lee (Powell)
Coffey Coffey

2 daughters, 1 son

**Bascom
Walker
Coffey**

Chart 1 of 1

Please return all corrections and additions to John Taylor, 1417 Claremont Avenue; Richmond, VA 23227

AUGUST, 1990

**Coffey Family History;
Daniel Rufus Coffey**

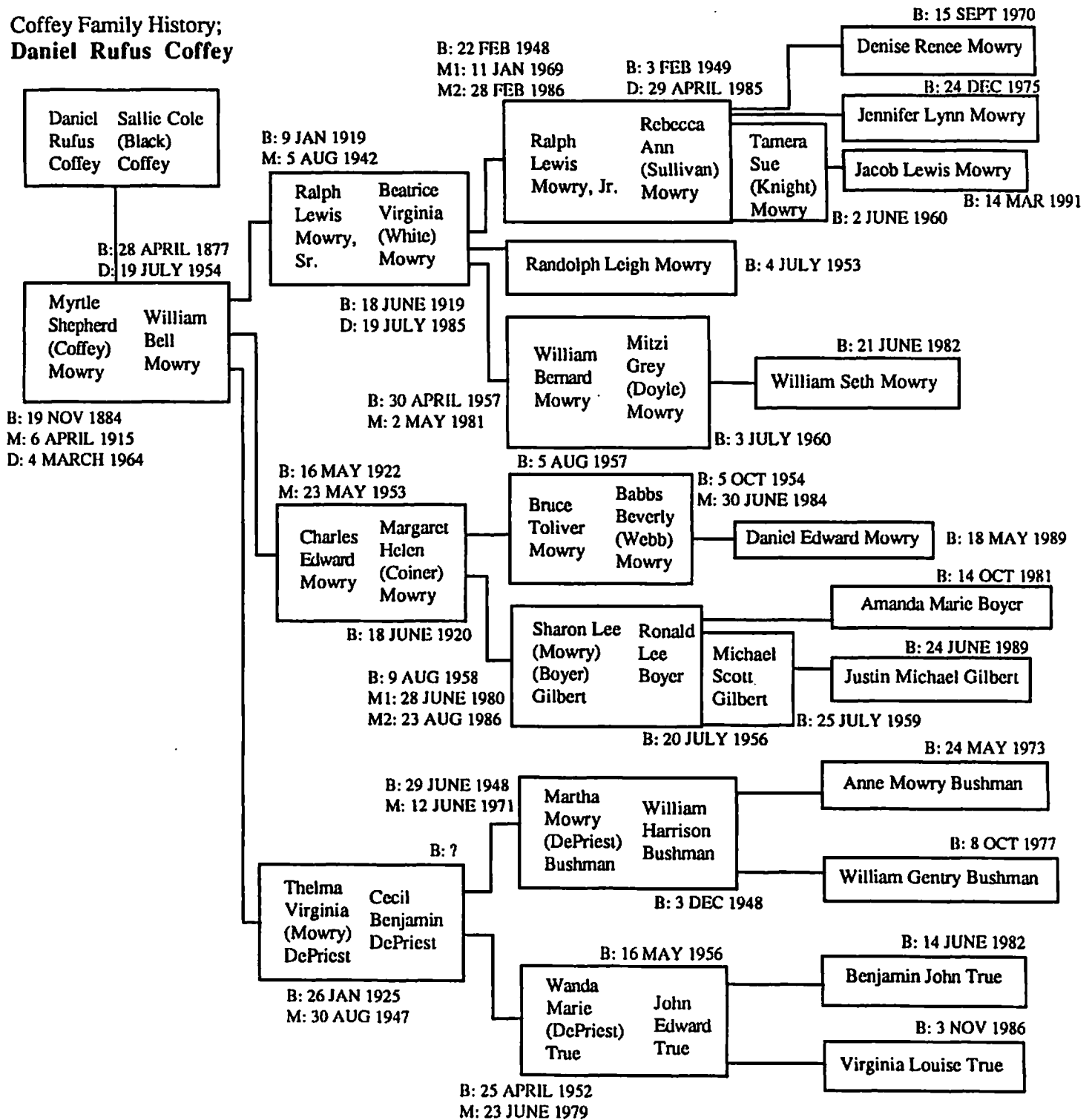

**Myrtle Shepard
(Coffey) Mowry**

Chart 1 of 1

AUGUST, 1990

Please return all corrections and additions to John Taylor, 1417 Claremont Avenue; Richmond, VA 23227

**Coffey Family History;
Daniel Rufus Coffey**

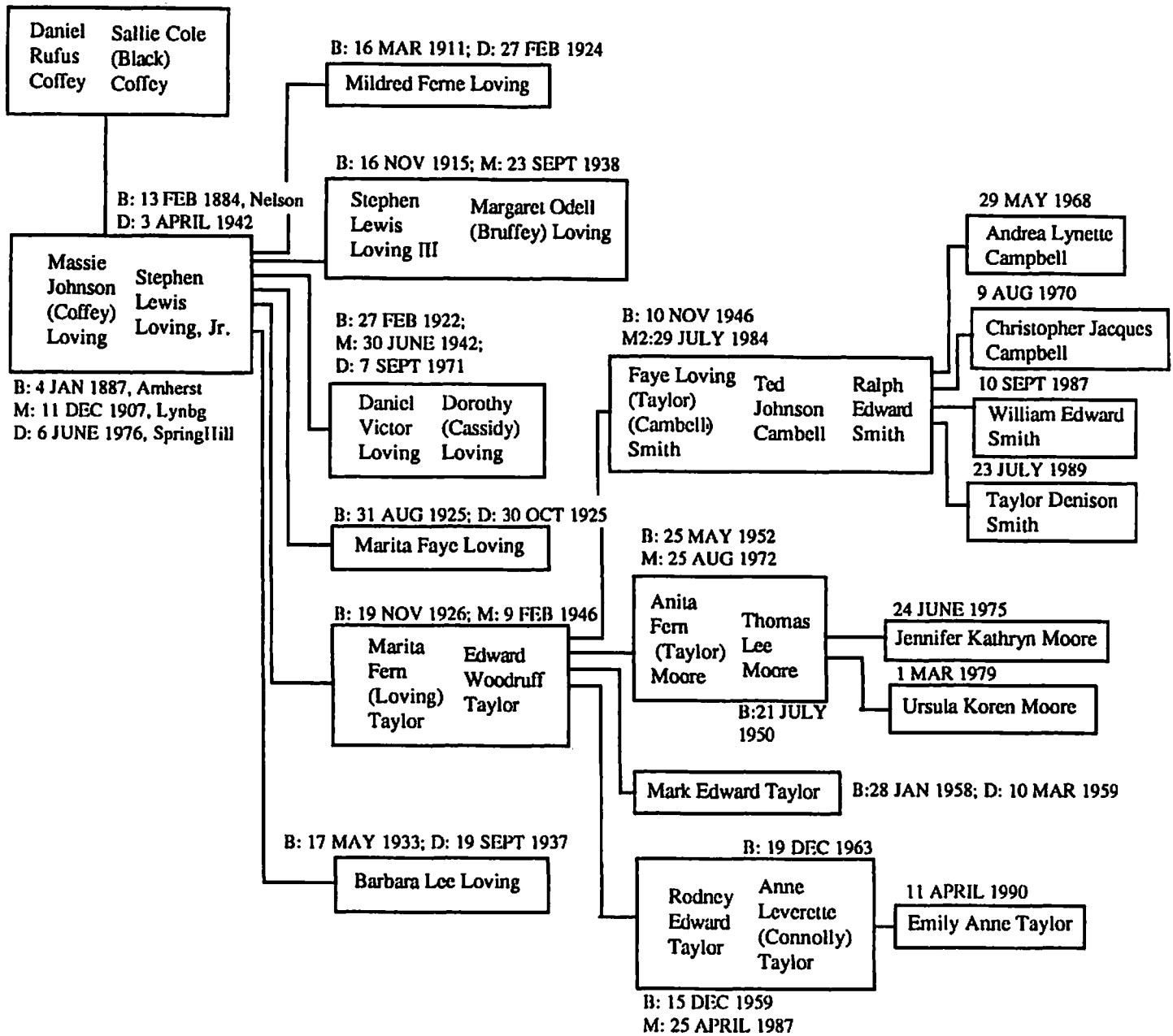

**Massie Johnson
(Coffey) Loving**

Chart 1 of 1

Please return all corrections and additions to John Taylor, 1417 Claremont Avenue; Richmond, VA 23227

AUGUST 1990

**Coffey Family History;
Daniel Rufus Coffey**

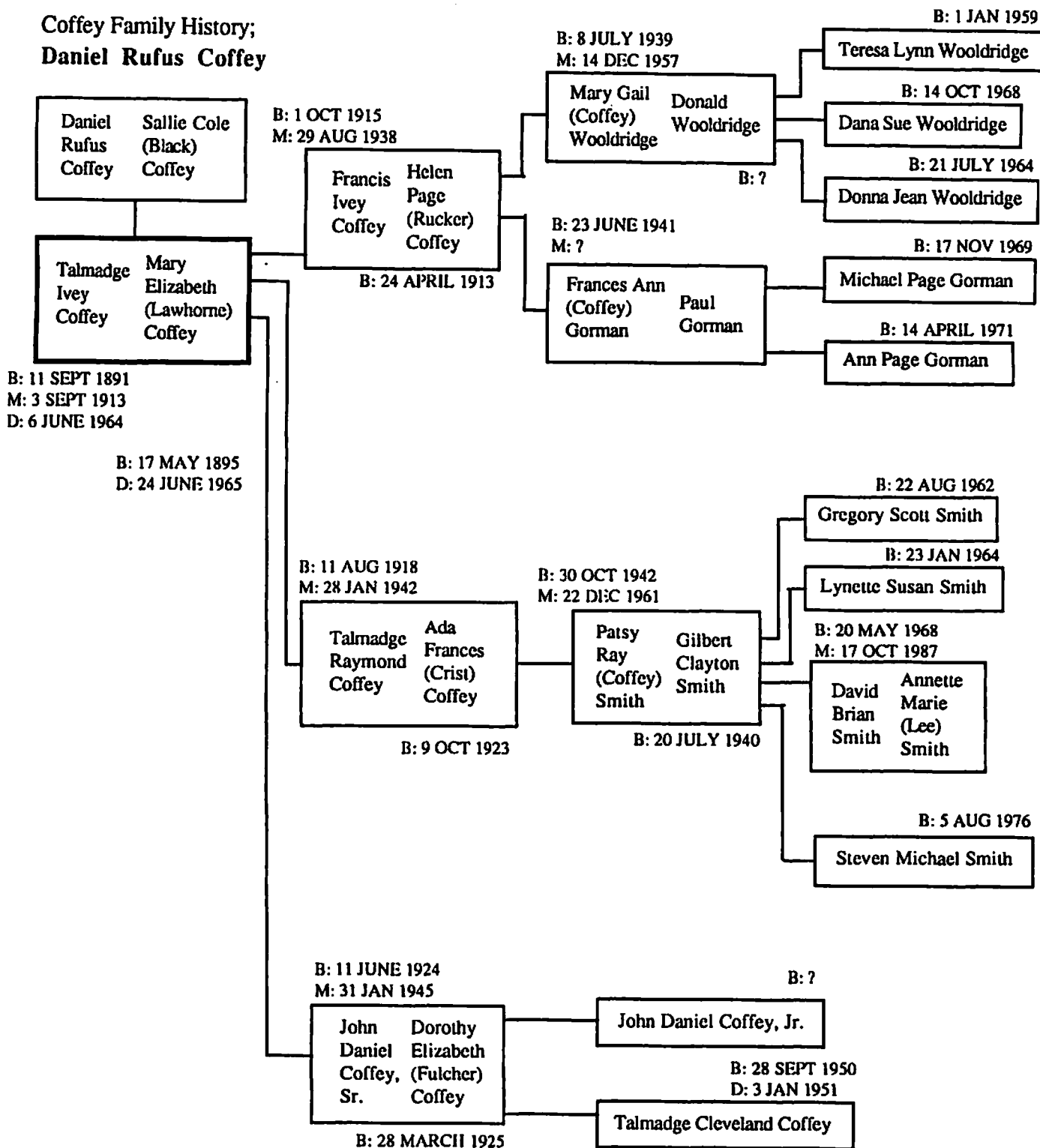

**Talmadge
Ivey
Coffey**

Chart 1 of 1
August, 1990

Please return all corrections and additions to John Taylor, 1417 Claremont Avenue; Richmond, VA 23227

**Coffey Family History;
Daniel Rufus Coffey**

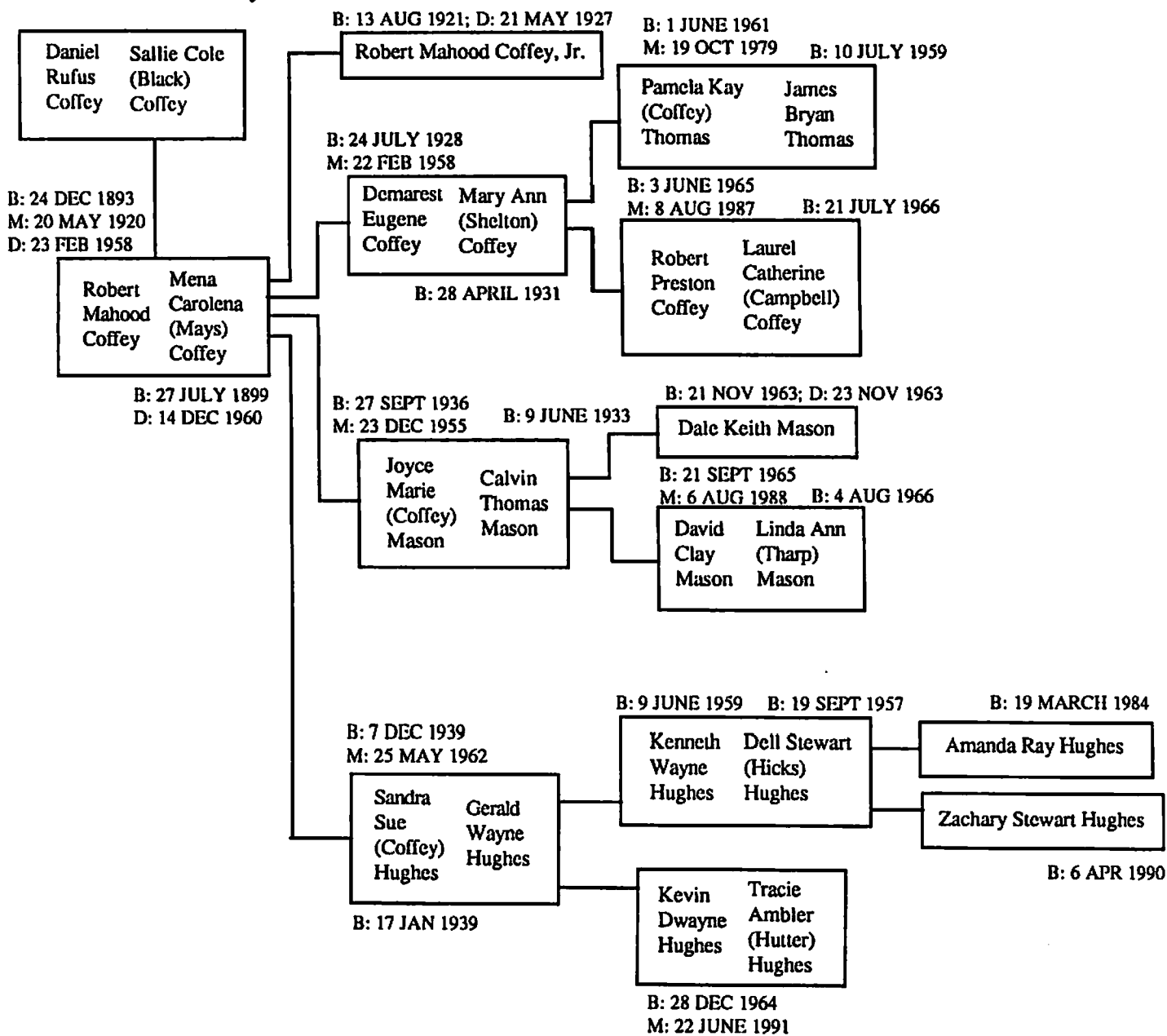

**Robert
Mahood
Coffey**

Chart 1 of 1

Please return all corrections and additions to John Taylor, 1417 Claremont Avenue; Richmond, VA 23227 SEPTEMBER, 1991

**Coffey Family History;
Daniel Rufus Coffey**

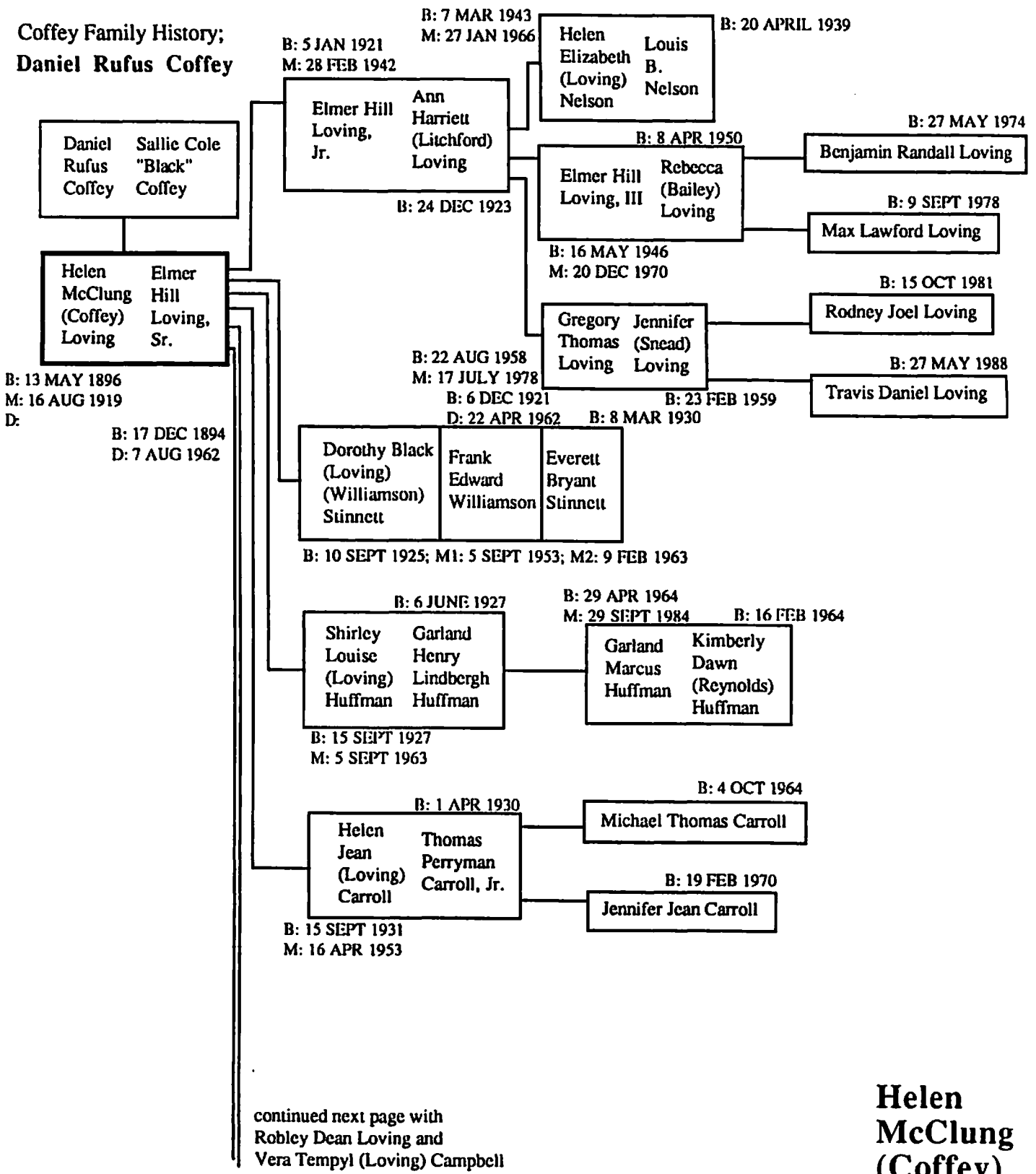

continued next page with
 Robley Dean Loving and
 Vera Tempyl (Loving) Campbell

**Helen
 McClung
 (Coffey)
 Loving**

Chart 1 of 2

**Coffey Family History;
Daniel Rufus Coffey**

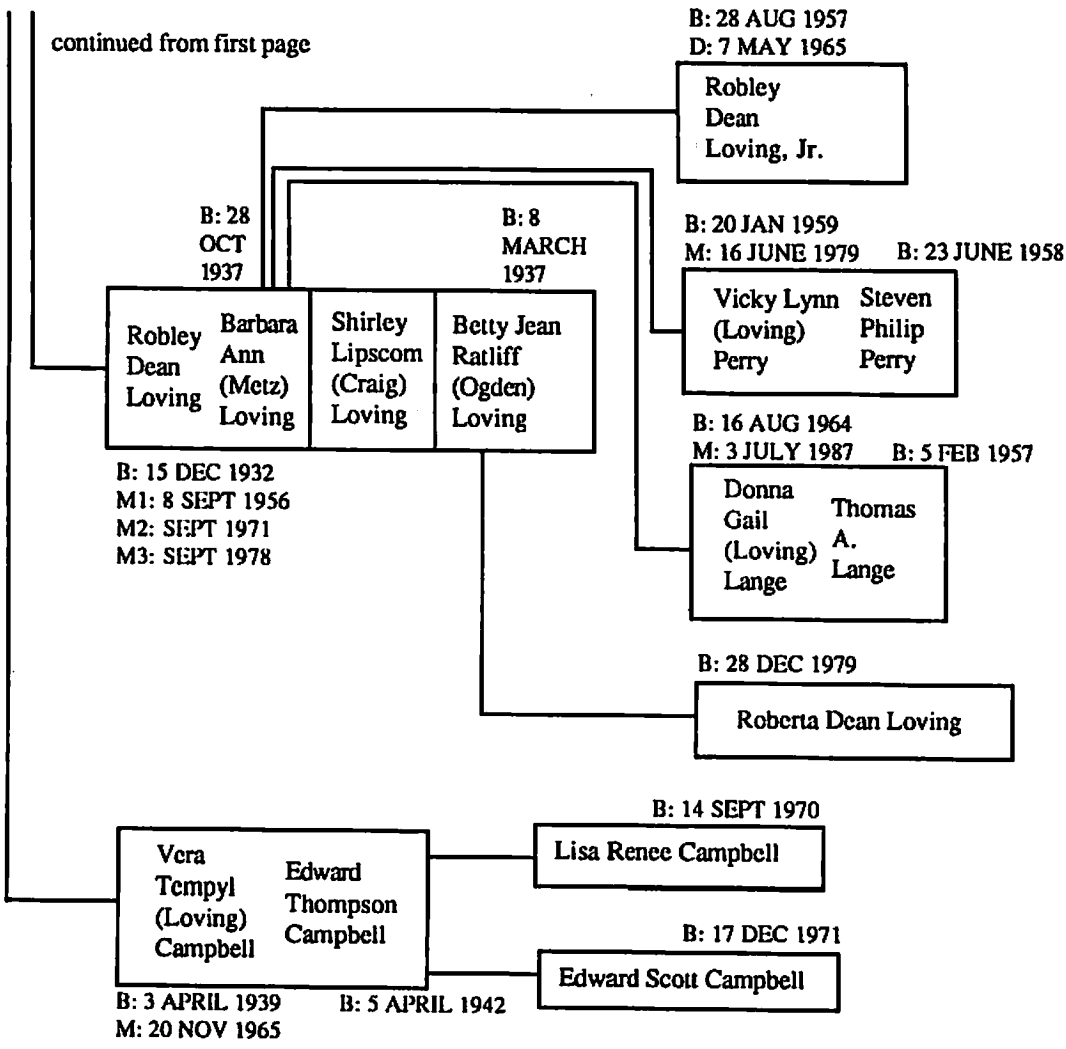

**Helen
McClung
(Coffey)
Loving**

Chart 2 of 2
AUGUST, 1990

Please return all corrections and additions to John Taylor, 1417 Claremont Avenue; Richmond, VA 23227

**Coffey Family History;
Daniel Rufus Coffey**

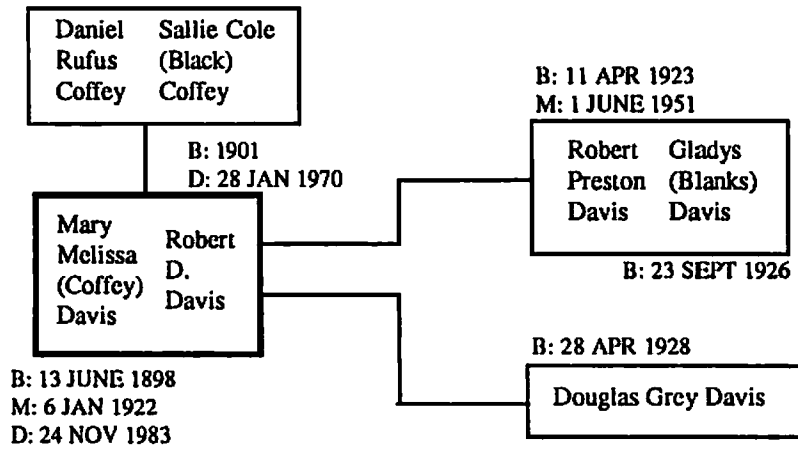

**Mary
Melissa
(Coffey)
Davis**

Chart 1 of 1

Please return all corrections and additions to John Taylor, 1417 Claremont Avenue; Richmond, VA 23227

AUGUST, 1990

**Coffey Family History;
Daniel Rufus Coffey**

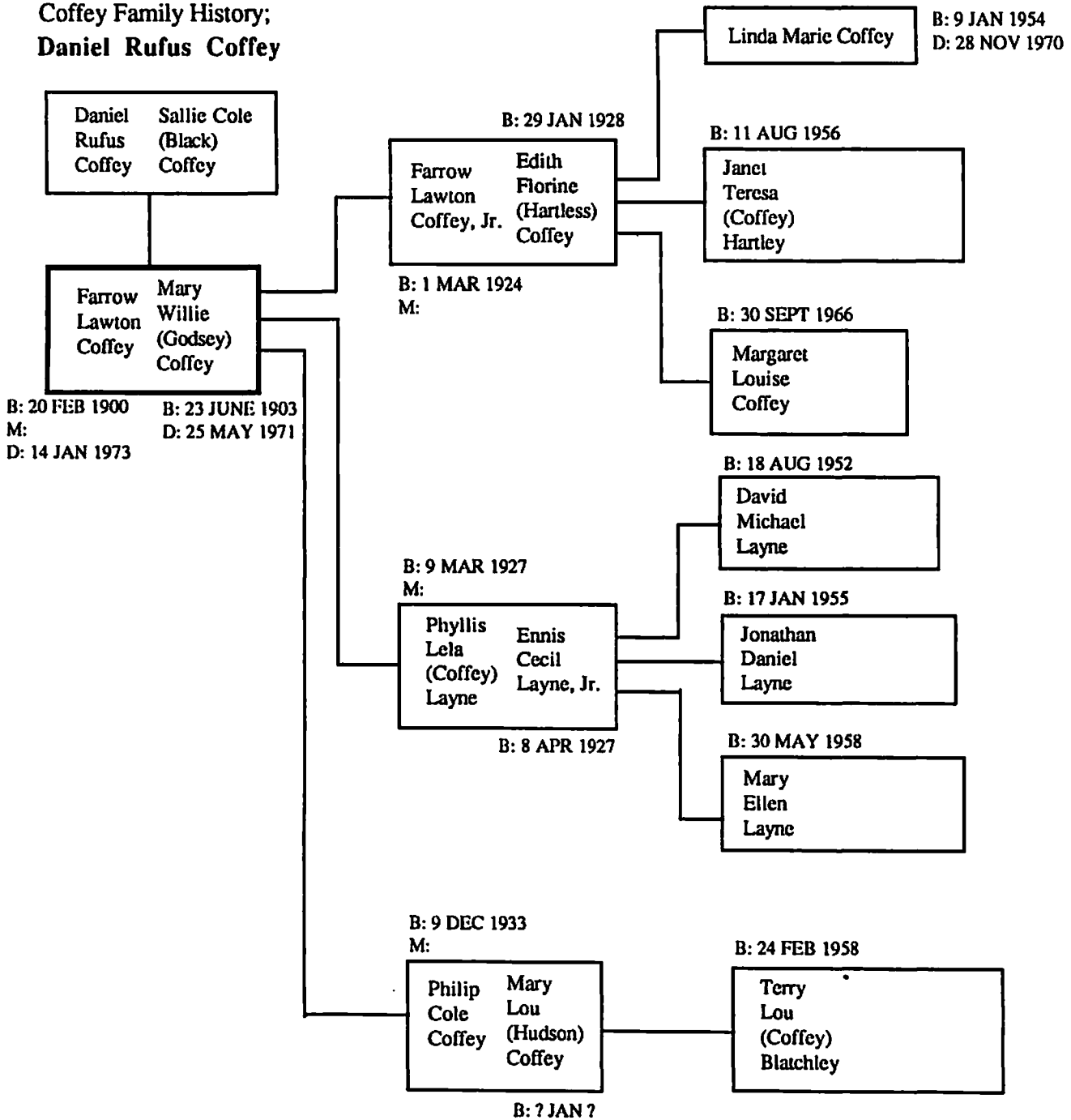

**Farrow
Lawton
Coffey**

Chart 1 of 1

Please return all corrections and additions to John Taylor, 1417 Claremont Avenue; Richmond, VA 23227

SEPTEMBER, 1991

**William
"Billy" and
Sarah Anne
"Sally"
(Crawford)
Coffey**

Coffey Family History;
Original Coffey Settlers in "Coffeytown"

WILLIAM "BILLY" COFFEY

Billy Coffey was probably the fourth son of Jordan and Elizabeth Coffey. According to his headstone he was born 9 April 1815. Other information indicates 23 April 1815 as his date of birth.

Billy married Sarah Ann "Sally" (Crawford) Coffey on 24 September 1835 in Amherst County. His parents are clearly listed as Jordan and Elizabeth Coffey. Her mother was Sarah Crawford. This couple, along with John Jack, Sr., had most of the population of what became Coffeytown.

Billy and his family built a house just north of Staton's Creek to the immediate west of Elsie Coffey's present house, where the family grew up. It was not until 1897 that the house Elsie lives in now was constructed.

Billy's headstone shows a death date as 11 May 1896. Death records show a William Coffey, unlisted parents, dying 26 July 1897. Evidently Billy's death came as a result of falling down the stairs at the original house, after he had returned from the new house. If this is true and the new house was not built until 1897, the 26 July date may be accurate. Otherwise, it could have been over a year since his death when it was reported in Amherst Courthouse, and the record shows the reported date, not the actual date; or, the listed William is not the right one. However, the listed Billy was 81 years old, which is right for his age. No other William of that age was known to be in Amherst County at the time.

"Sally" and Billy Coffey are buried on the hill behind Elsie Coffey's house in a fenced-in area which includes Bettie Coffey, their unmarried daughter. Bettie evidently died of grief, as she was very attached to her mother. Others in the cemetery include Walter Campbell, perhaps related to John Jack's second wife, or to one of John Jack Jr.'s two daughters, Lena and Emma Jane, who married Campbell men in sufficient time to have had Walter. Robert H. Coffey, great-grandson of Billy Coffey, grandson of Harden Coffey and Hersey Coffey's brother, has the only other marked grave (1903-1907) in this cemetery.

(July, 1992)

Coffey Family History;
Original Coffey Settlers in "Coffeytown"
WILLIAM "BILLY" COFFEY

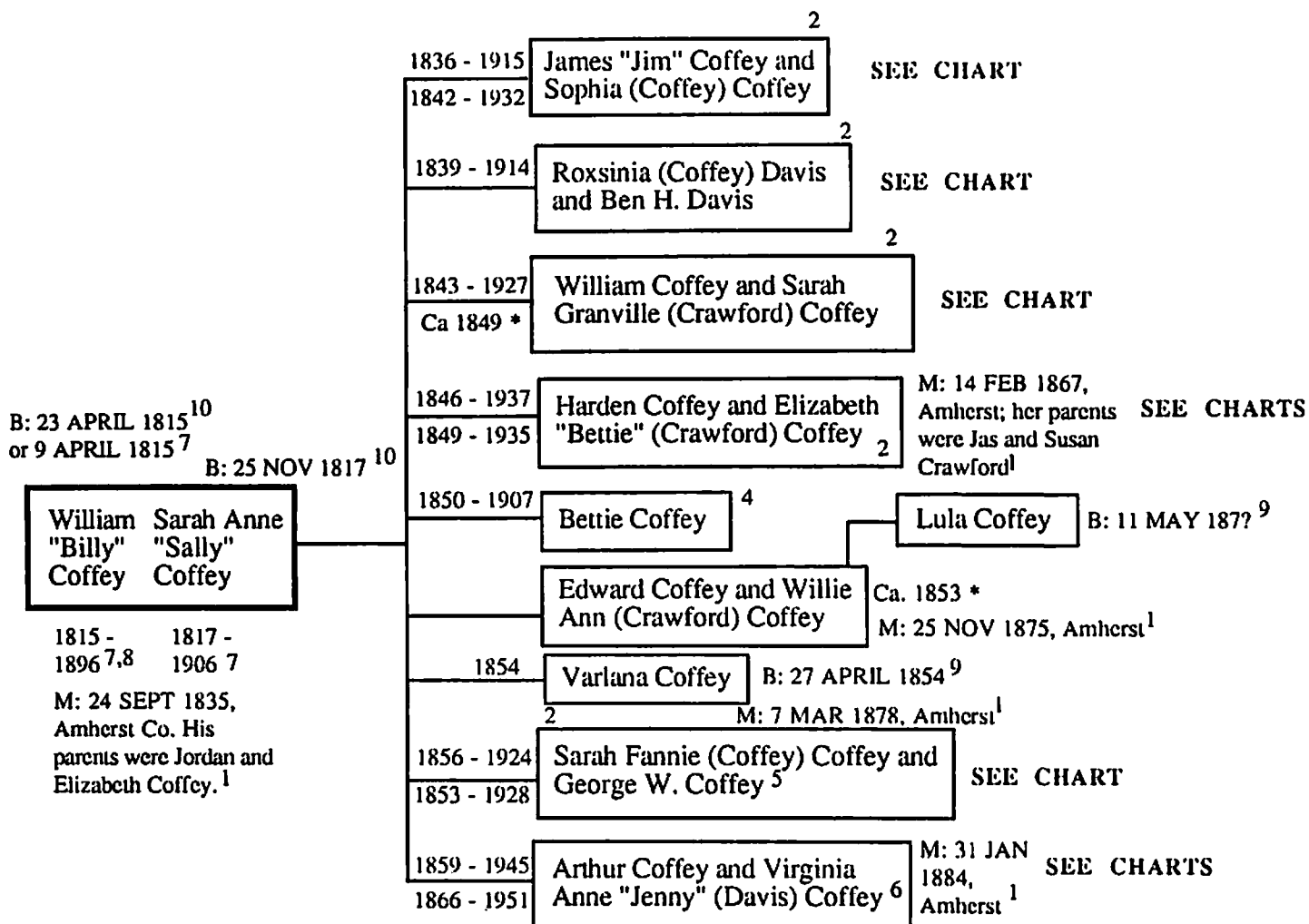

1. From Amherst County Marriage Records in State Archives.
2. Buried in Bridgehill, dates from headstones.
3. Am Co Death records, she died of Cholera, born in Fluvanna County to Joshua and Besley Duff.
4. Never married, buried in family plot behind Elsie Coffey's house.

5. Marriage records: parents were Rubin W. and S.T. Coffey; George was born in Nelson County.
6. Her parents were Avarilla and Wm W Davis.
7. Buried behind Elsie Coffey's house, dates from headstones which were set some years after deaths.
8. Some William Coffey died 7-26-1897 in Amherst Co., aged 81, no parents listed in records. Billy died as a result of falling down the stairs in the dark, after rising to open the window, according to Elsie Coffey.

9. Statewide Birth Index
10. From Diane M. Gardner

**WILLIAM
"BILLY"
COFFEY
AND
FAMILY**

JULY, 1992

Please return all additions and corrections to John Taylor, 1417 Claremont Avenue; Richmond, VA 23227

Coffey Family History;
WILLIAM "BILLY" COFFEY

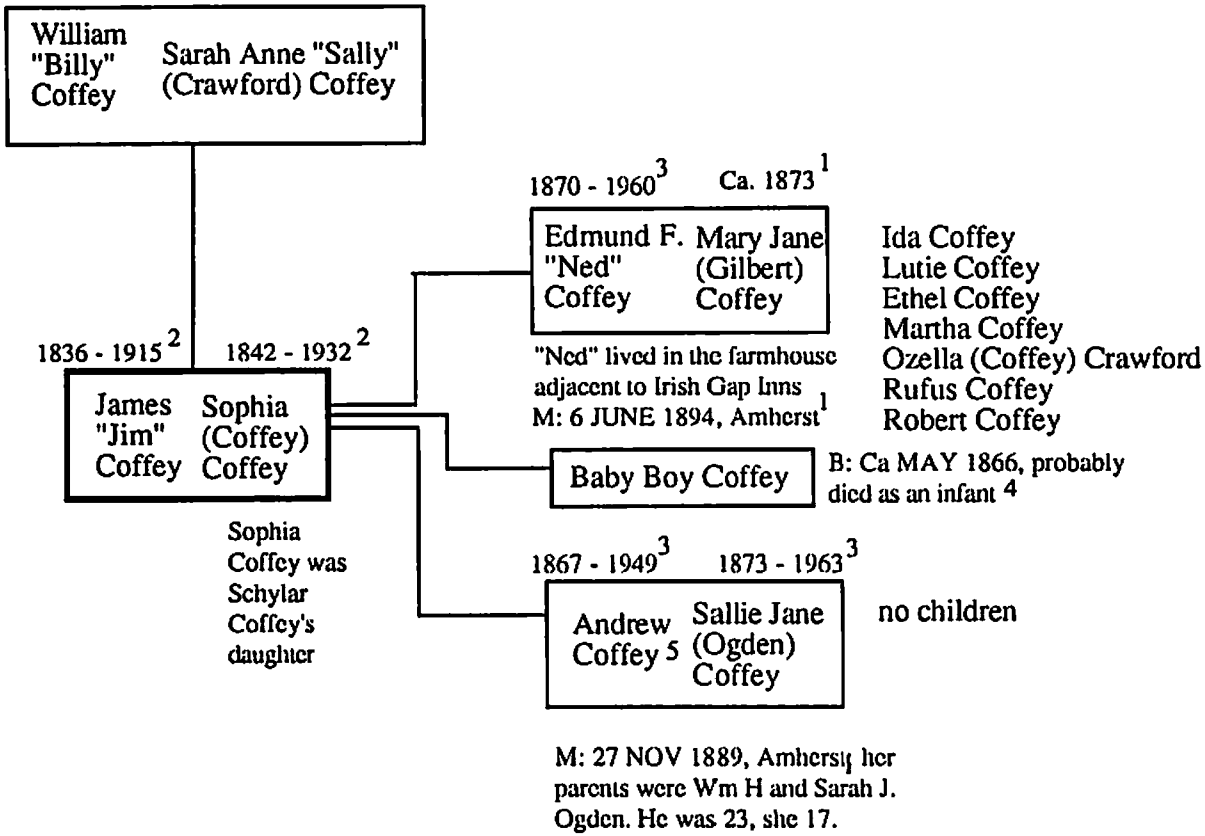

1. From Amherst County Marriage Records, State Archives.
2. Buried in Bridgchill cemetery, dates from headstone.
3. Buried in Greenhill Cemetery, Bucna Vista, dates from headstones.
4. Statewide Birth Index, State Archives.
5. Statewide Birth Index shows a male born to "Jas & Sophia" in SEPT 1867, probably Andrew.

**JAMES
 "JIM"
 COFFEY**

Please return all additions and corrections to John Taylor, 1417 Claremont Avenue; Richmond, VA 23227

JULY, 1992

**Coffey Family History;
Roxsinia (Coffey) Davis**

B: 9 APR 1815¹

M:

D: 11 MAY 1896¹

William "Billy" Coffey	Sarah Anne "Sally" Coffey
------------------------------	------------------------------------

B: 25 NOV 1817
D: 11 OCT 1906

B: 12 MAY 1839²

M:

D: 2 OCT 1914²

Roxsinia (Coffey) Davis	Ben H. Davis
-------------------------------	-----------------

Will Davis

Daniel Davis

Harden Davis

Paul Davis

Laura (Davis)

Luella (Davis)

- 1. Buried behind Elsie Coffey's house, dates from Headstones.
- 2. Buried Bridgehill, dates from headstones.

ROXSINIA (COFFEY) DAVIS
--

Coffey Family History;
WILLIAM "BILLY" COFFEY

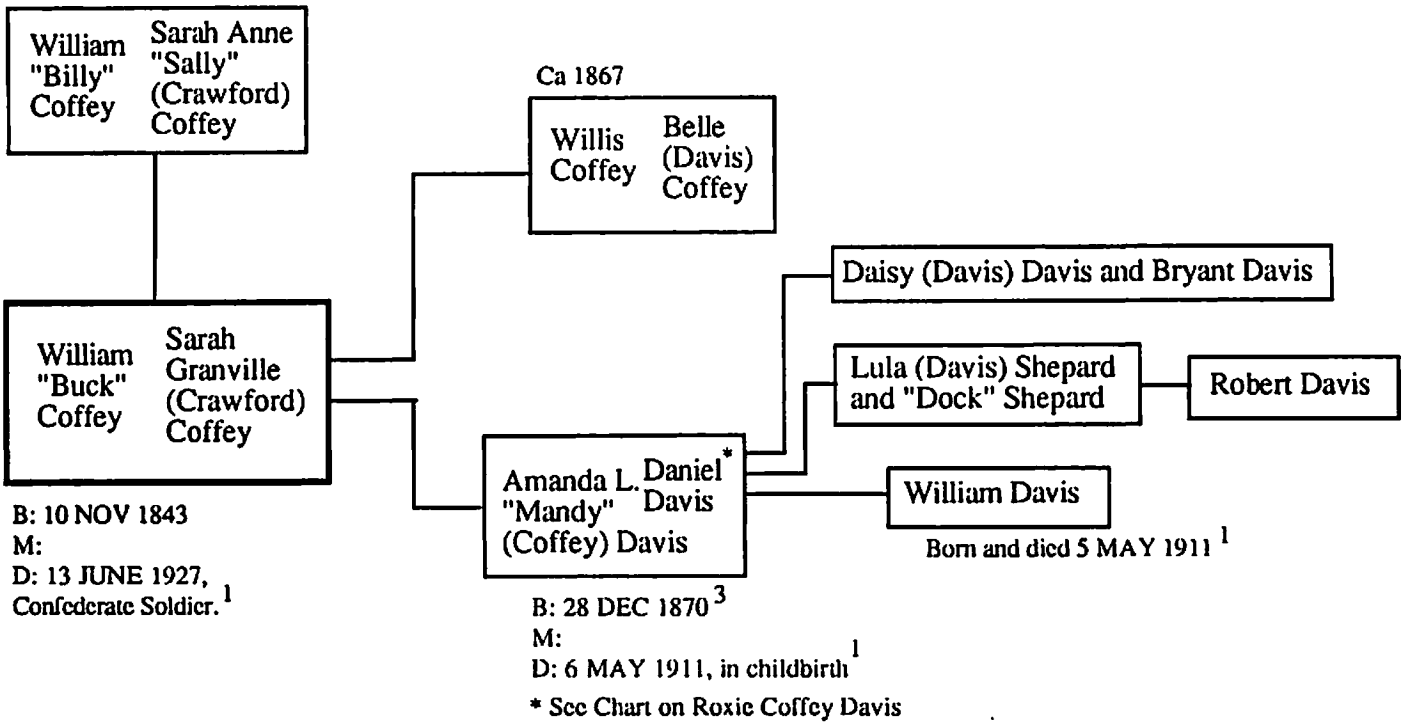

- 1. Buried in Bridgchill, dates from headstone.
- 2. From Amherst County Marriage Records.
- 3. Statewide Birth Index.

**William
 "Buck"
 Coffey**

**Coffey Family History;
WILLIAM "BILLY" COFFEY**

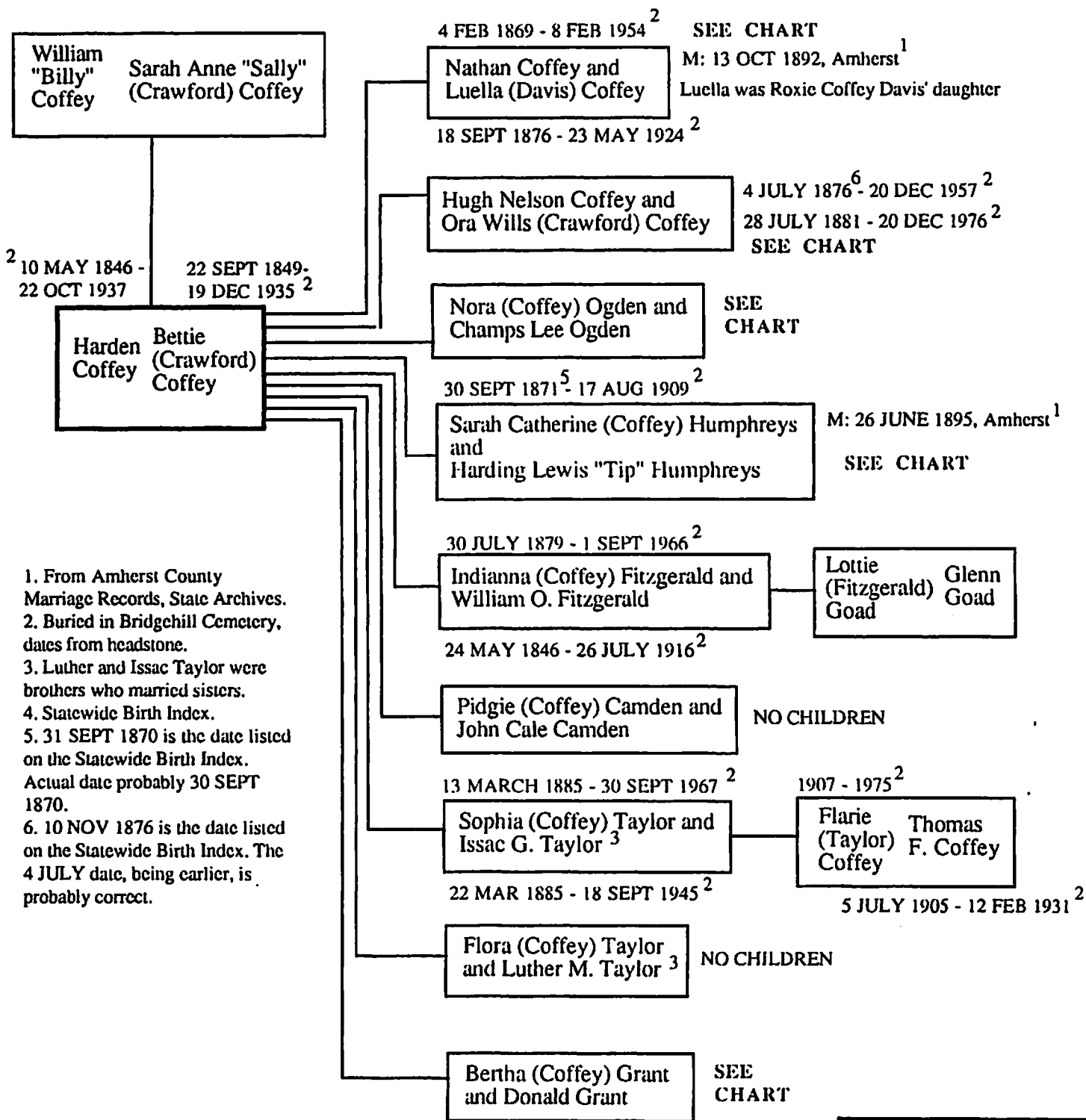

1. From Amherst County Marriage Records, State Archives.
2. Buried in Bridgehill Cemetery, dates from headstone.
3. Luther and Issac Taylor were brothers who married sisters.
4. Statewide Birth Index.
5. 31 SEPT 1870 is the date listed on the Statewide Birth Index. Actual date probably 30 SEPT 1870.
6. 10 NOV 1876 is the date listed on the Statewide Birth Index. The 4 JULY date, being earlier, is probably correct.

**HARDEN
COFFEY**

**Coffey Family History;
Harden Coffey**

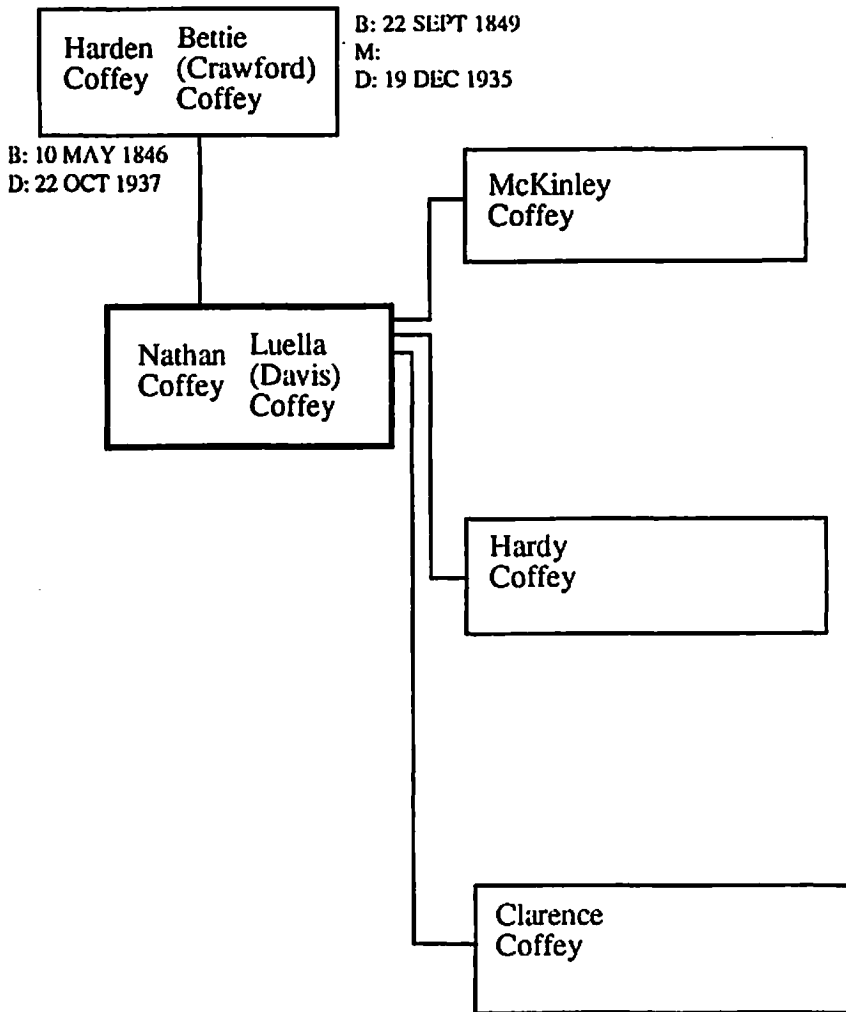

**Nathan
Coffey**

Chart 1 of 1

Please return all additions and corrections to John Taylor, 1417 Claremont Avenue; Richmond, VA. FEBRUARY, 1991

**Coffey Family History;
Harden Coffey**

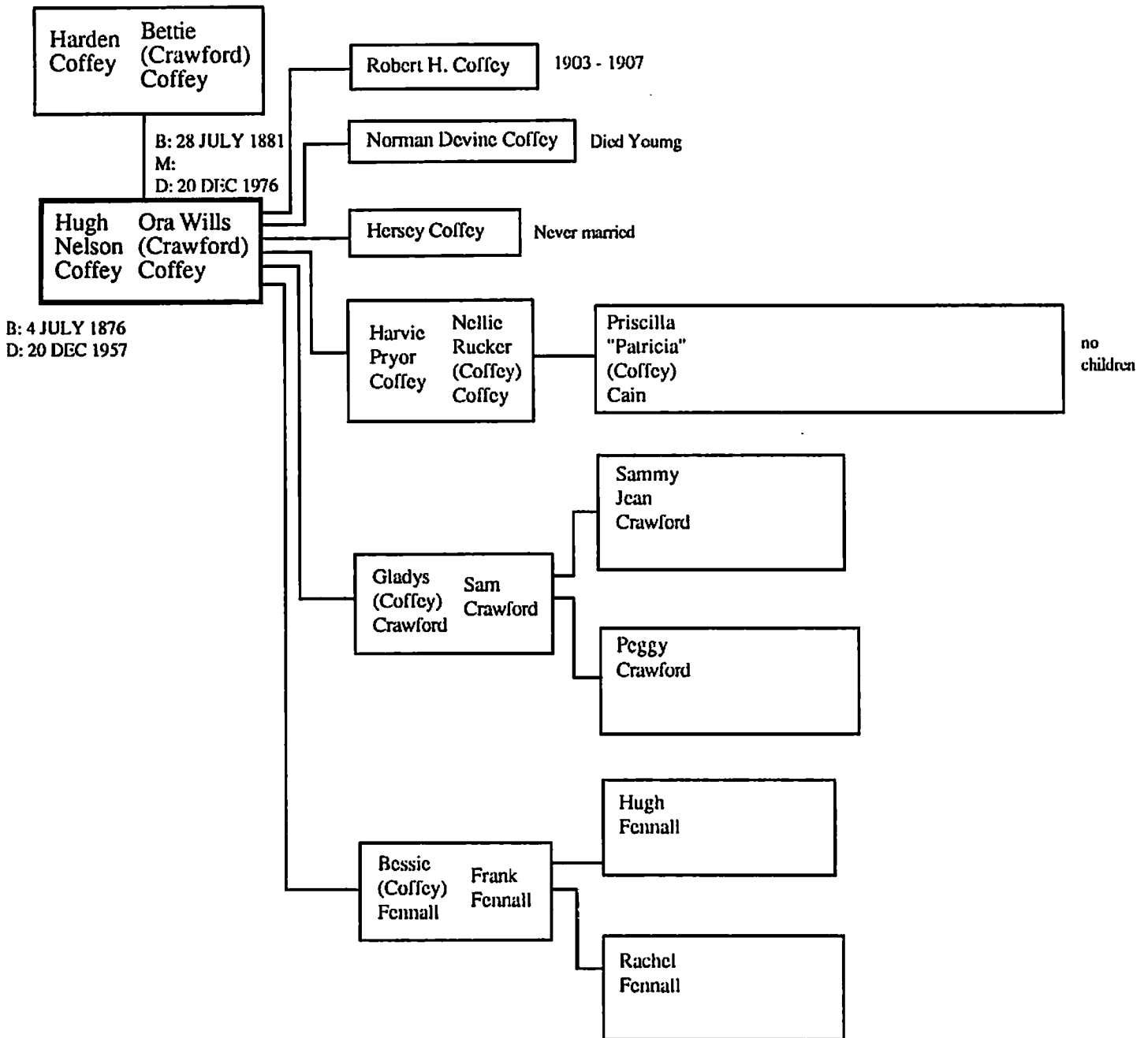

**Hugh
Nelson
Coffey**

Chart 1 of 1

**Coffey Family History;
Harden Coffey**

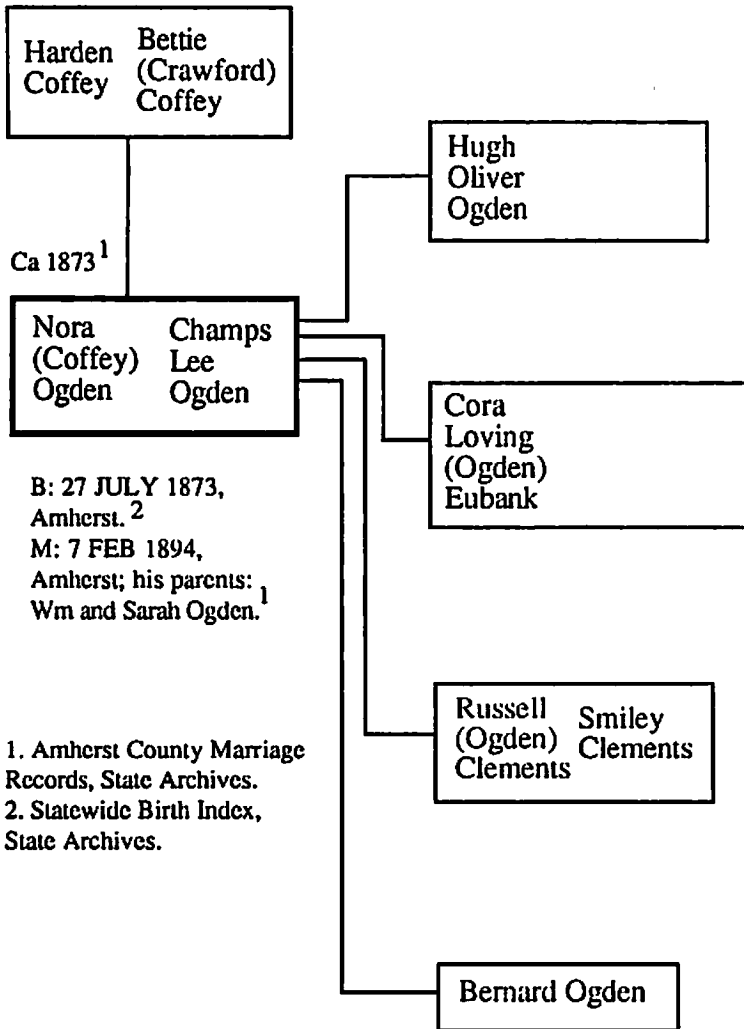

**Nora
(Coffey)
Ogden**

Chart 1 of 1

Please return all additions and corrections to John Taylor, 1417 Claremont Avenue; Richmond, VA. JULY, 1992

**Coffey Family History;
Harden Coffey**

B: 26 JULY 1898
M:
D: 23 JULY 1967 ²

Harden Coffey Bettie
(Crawford)
Coffey

Harding Lewis Humphreys, Jr. Sarah Cora (Maddox) Humphreys

Agnes Humphreys

Lena Humphreys

John Henry Humphreys

Sarah Catherine (Coffey) Humphreys Harding Lewis "Tip" Humphreys

B: 30 SEPT 1871
M: 26 JUNE 1895, Amherst ¹
D: 17 AUG 1909 ²

Rucker Humphreys

Frank Humphreys

Tumer Humphreys

Sophia (Humphreys) Fitzgerald

Berta (Humphreys) Cambell

NOTES

1. From Amherst County Marriage Records, State Archives.
2. Buried in Bridgehill Cemetery, dates from headstone.

**Sarah
Catherine
(Coffey)
Humphreys**

Chart 1 of 1
JULY, 1992

**Coffey Family History;
Harden Coffey**

12 JUNE 1917 - 13 OCT 1917 ¹

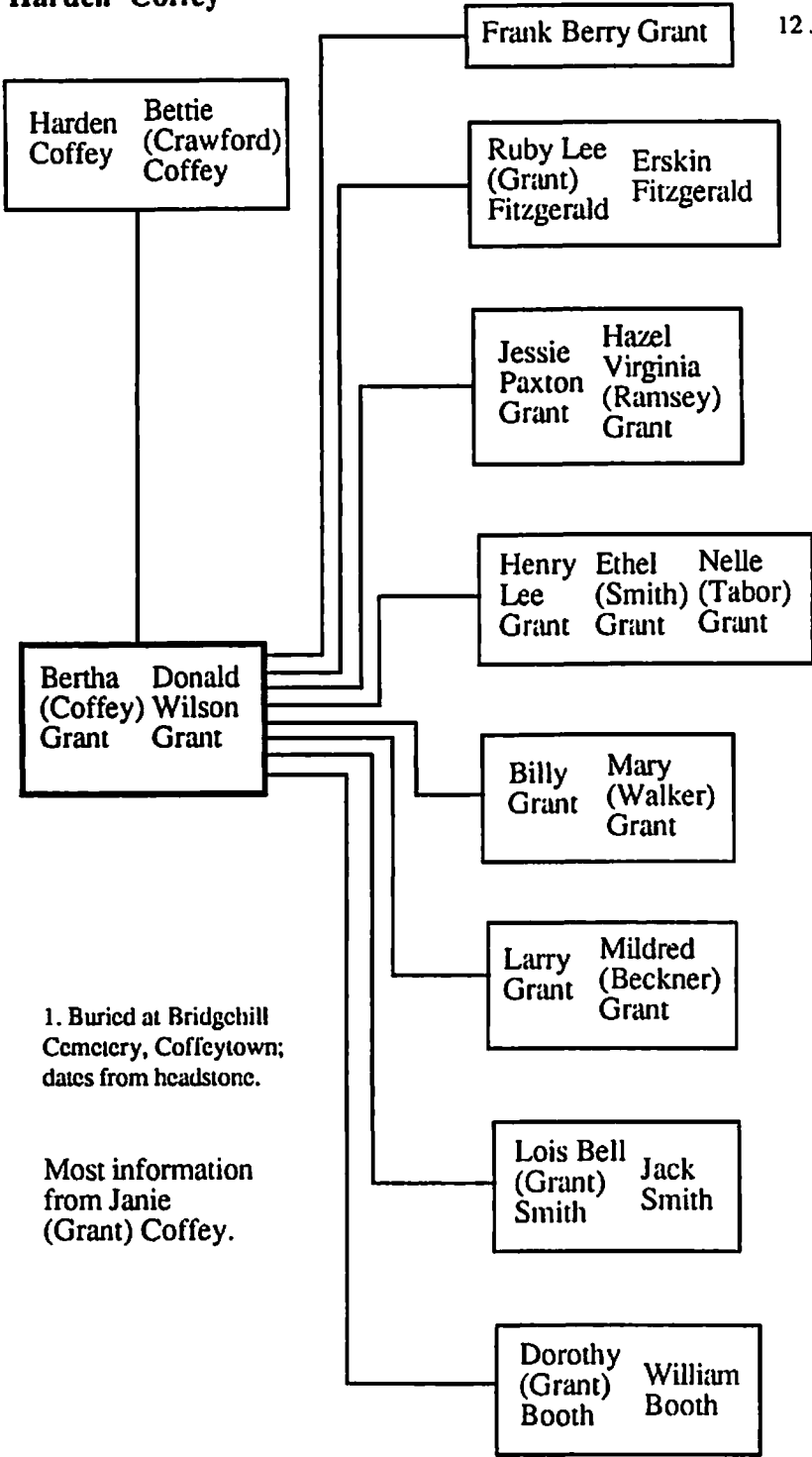

1. Buried at Bridgehill Cemetery, Coffeytown; dates from headstone.

Most information from Janie (Grant) Coffey.

Bertha (Coffey) Grant

Chart 1 of 1
JULY, 1992

Coffey Family History;
WILLIAM "BILLY" COFFEY

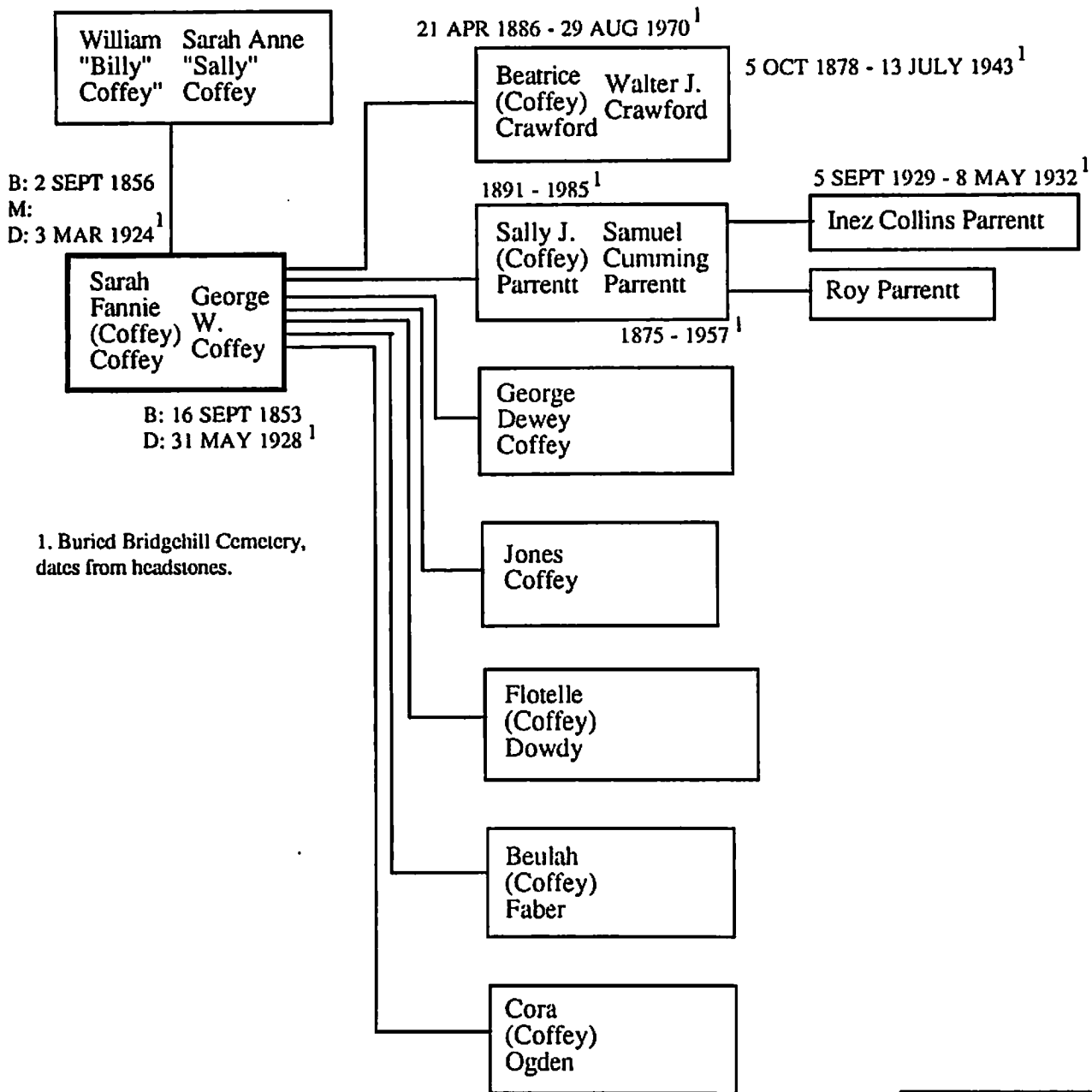

1. Buried Bridgehill Cemetery, dates from headstones.

**SARAH
 FANNIE
 (COFFEY)
 COFFEY**

Coffey Family History;
WILLIAM "BILLY" COFFEY

William "Billy"
Coffey

Sarah Anne "Sally"
(Crawford)
Coffey

B: 15 AUG 1866
 D: 14 MAY 1951¹

Arthur
Coffey

Virginia Anne "Jenny"
(Davis)
Coffey

B: 10 AUG 1859¹
 M: 31 JAN 1884, Amh Co.²
 D: 30 MAR 1945¹

1. Buried Greenhill Cemetery, Buena Vista, dates from headstone.
 2. Amherst County Marriage Records.

Leonard Elsie
Carlyle (Coffey)
Coffey Coffey

SEE CHART

Hiram Susie A.
Randolph (Catlett)
Coffey Coffey

No children

Ernest Ethel
Webster (Stratton)
Coffey Coffey

SEE CHART

Fletcher Maggie
Beadles (Harris)
Coffey Coffey

SEE CHART

Mabel Emmett
(Coffey) Humphries
Humphries

SEE CHART

Alma T. Powell
(Coffey) Crawford
Crawford

SEE CHART

Hallie J.
(Coffey) Houston
Crawford Crawford

SEE CHART

Sally Glenn
(Coffey) Wyatt
Wyatt

SEE CHART

Essie Emmett
(Coffey) Sales
Sales

SEE CHART

Mina William
(Coffey) Thompson Davis
(Davis) Davis Gibson
Gibson

SEE CHART

**ARTHUR
COFFEY**

**Coffey Family History;
Arthur Coffey**

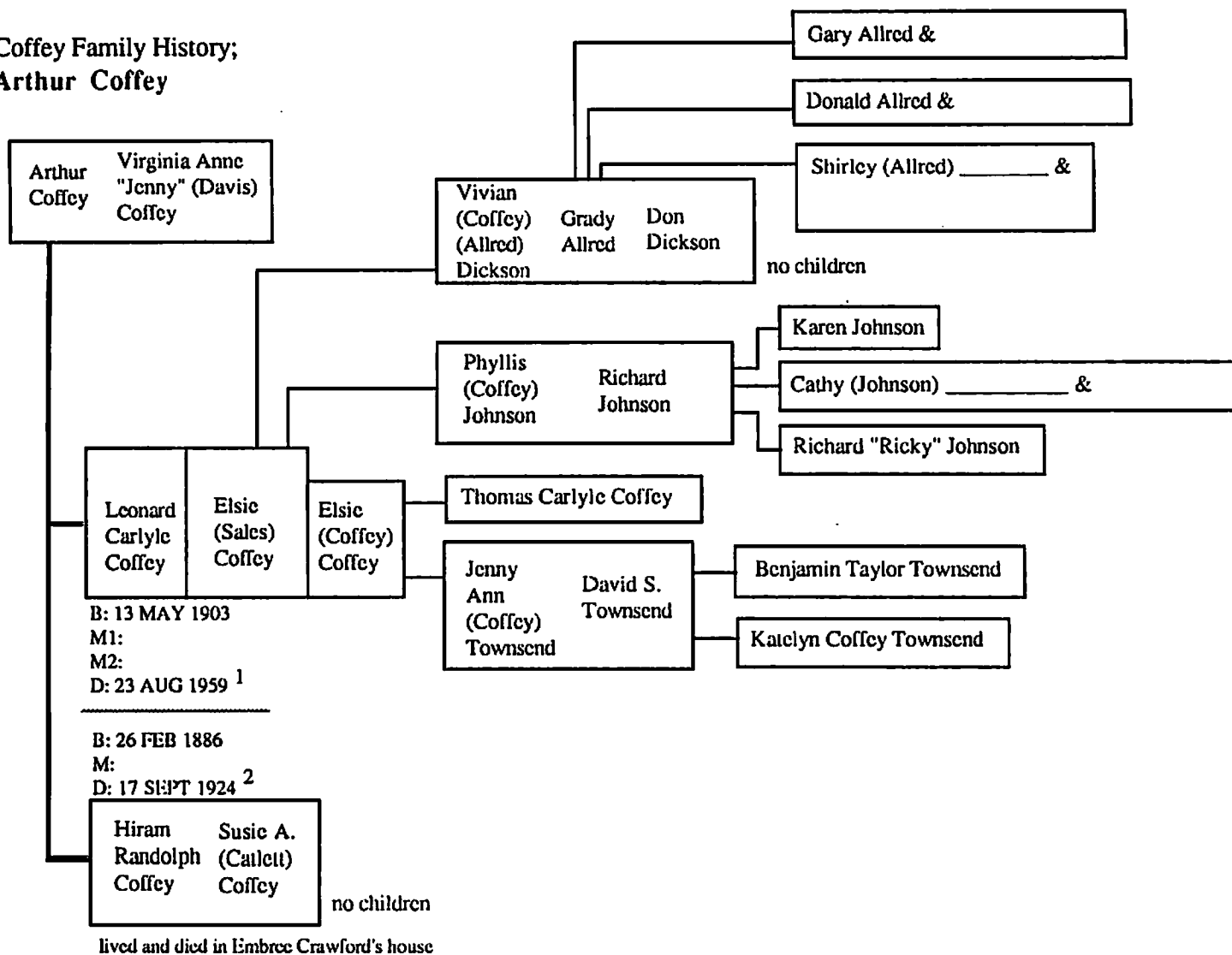

1. Buried Greenhill Cemetery, Buena Vista, dates from headstone.
2. Buried Bridgehill Cemetery, Coffeytown, dates from headstone.

**Leonard
and Hiram
Randolph
Coffey**

Chart 1 of 1

MAY, 1991

Please return all additions and corrections to John Taylor, 1417 Claremont Avenue; Richmond, VA 23227

**Coffey Family History;
Arthur Coffey**

B: 15 AUG 1867,
Buena Vista ²

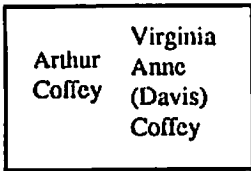

1859 - 1945 ¹

1866 - 1951 ¹

B: 10 AUG ²
1859, Amh.

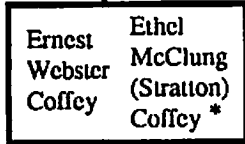

1888 - 1962 ¹

1892 - 1965 ¹

B: 5 FEB 1888 ²

B: 3 JUNE 1892,
Buena Vista ²

* Grand-daughter of Charles Edward Coffey, daughter of Elieanna Coffey

1. Buried Greenhill Cemetery, Buena Vista, dates from headstone.
2. From Diane M. Gardner.

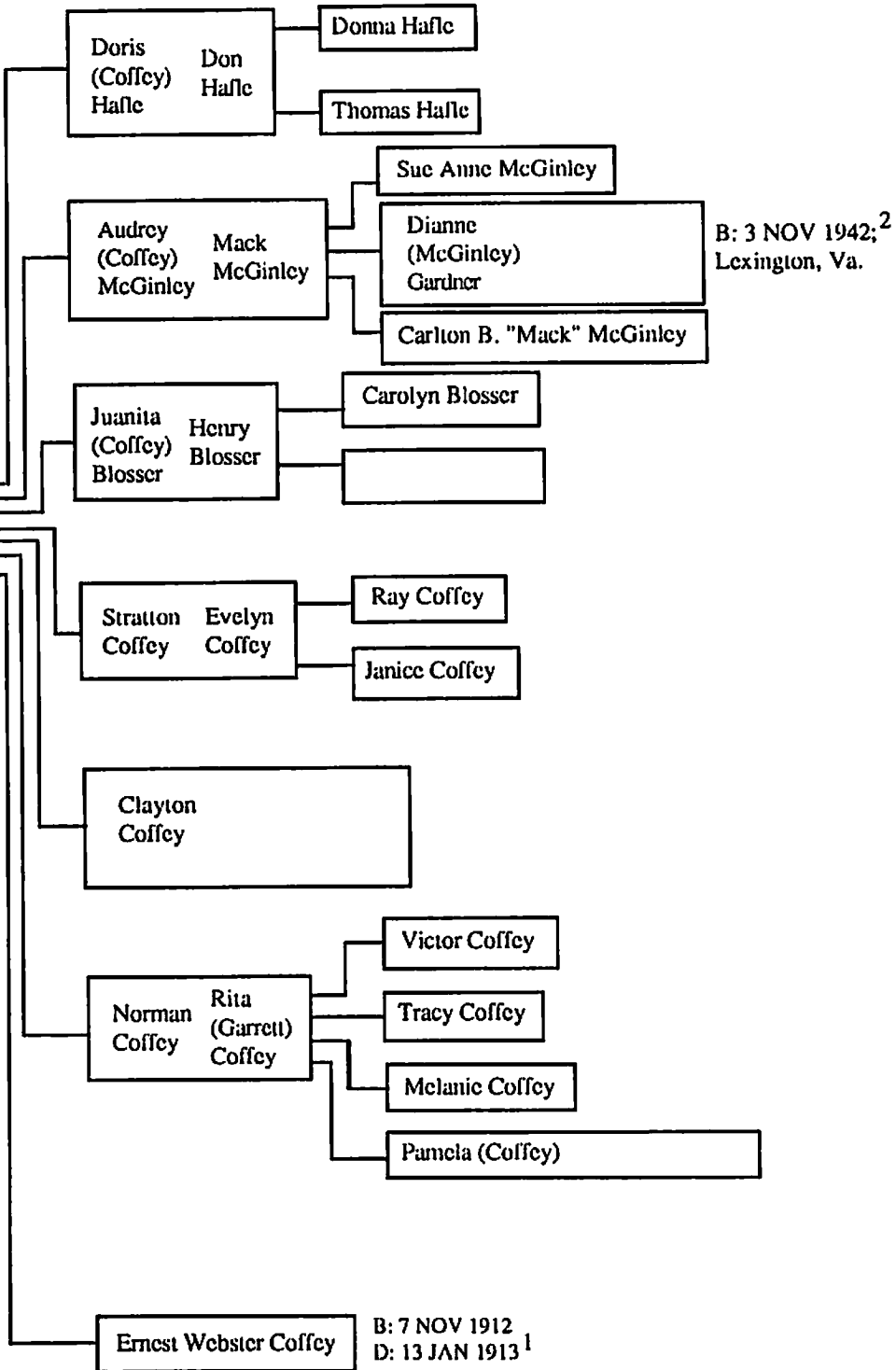

Ernest Webster Coffey

Chart 1 of 1
JULY, 1992

**Coffey Family History;
Arthur Coffey**

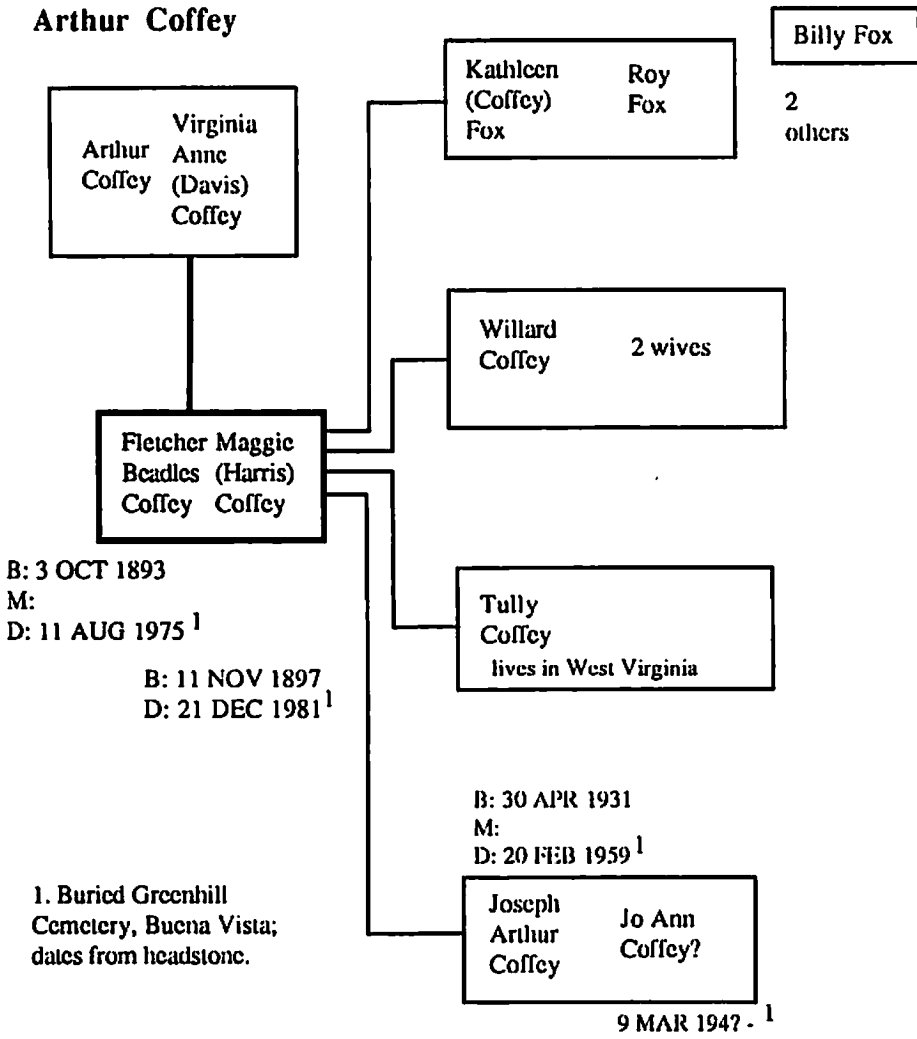

**Fletcher
Beadles
Coffey**

Chart 1 of 1

**Coffey Family History;
Arthur Coffey**

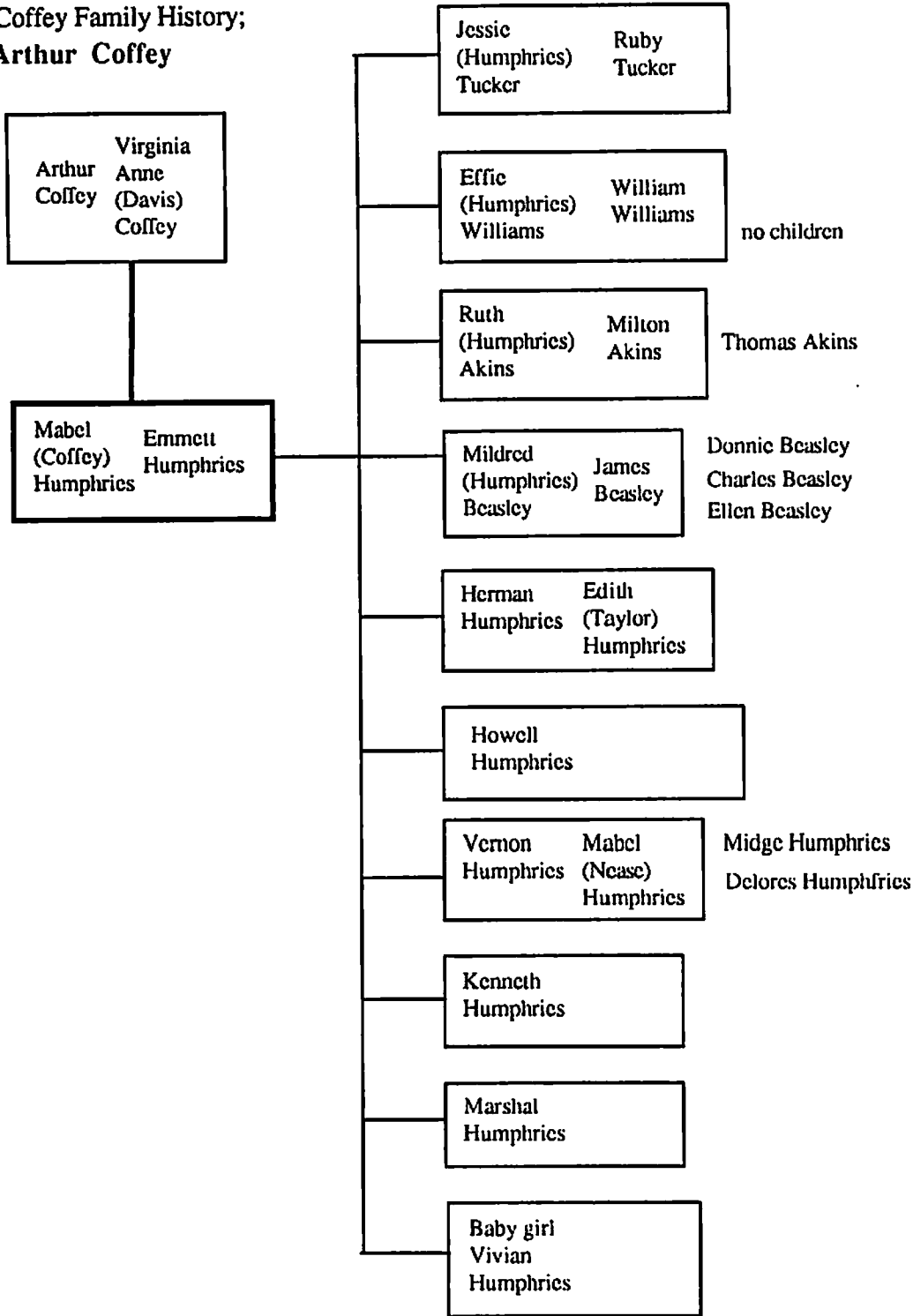

**Mabel
(Coffey)
Humphries**

Chart 1 of 1
JULY, 1992

Please return all additions and corrections to John Taylor, 1417 Claremont Avenue; Richmond, VA 23227

**Coffey Family History;
Arthur Coffey**

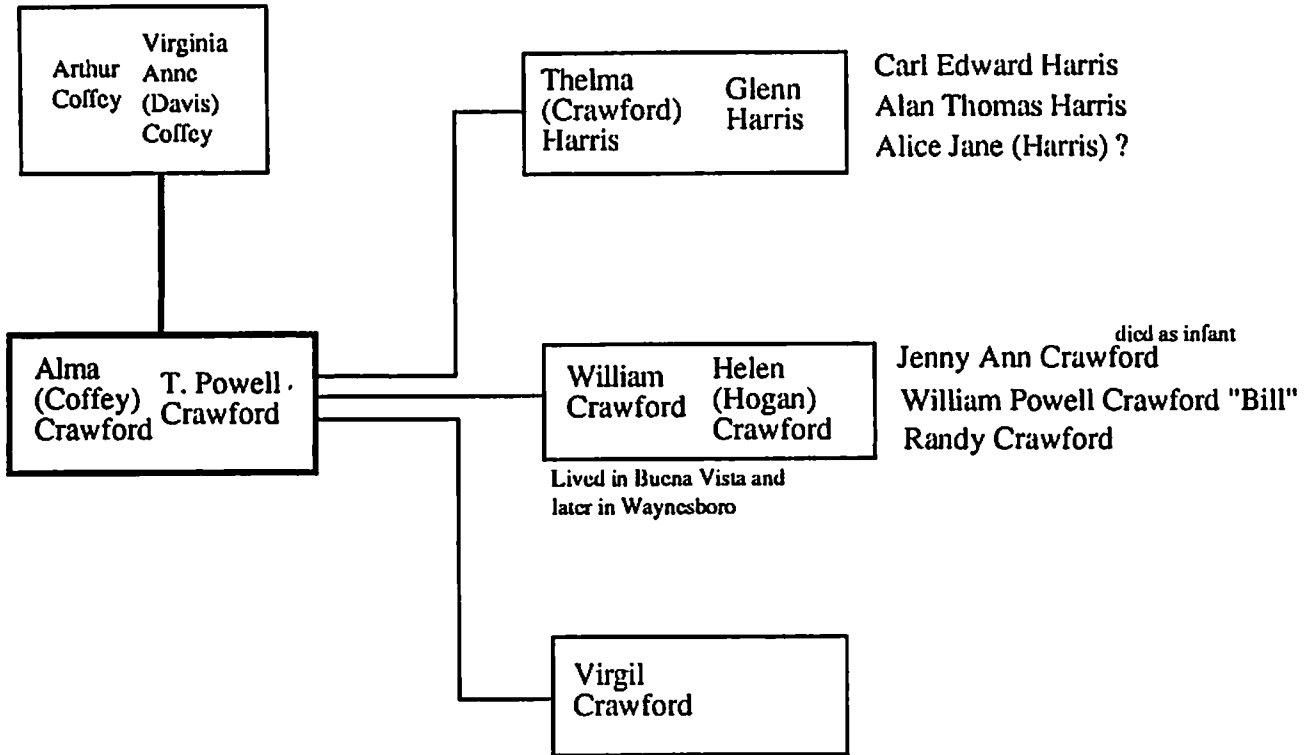

**Alma
(Coffey)
Crawford**

Chart 1 of 1
JULY, 1992

Please return all additions and corrections to John Taylor, 1417 Claremont Avenue; Richmond, VA 23227

**Coffey Family History;
Arthur Coffey**

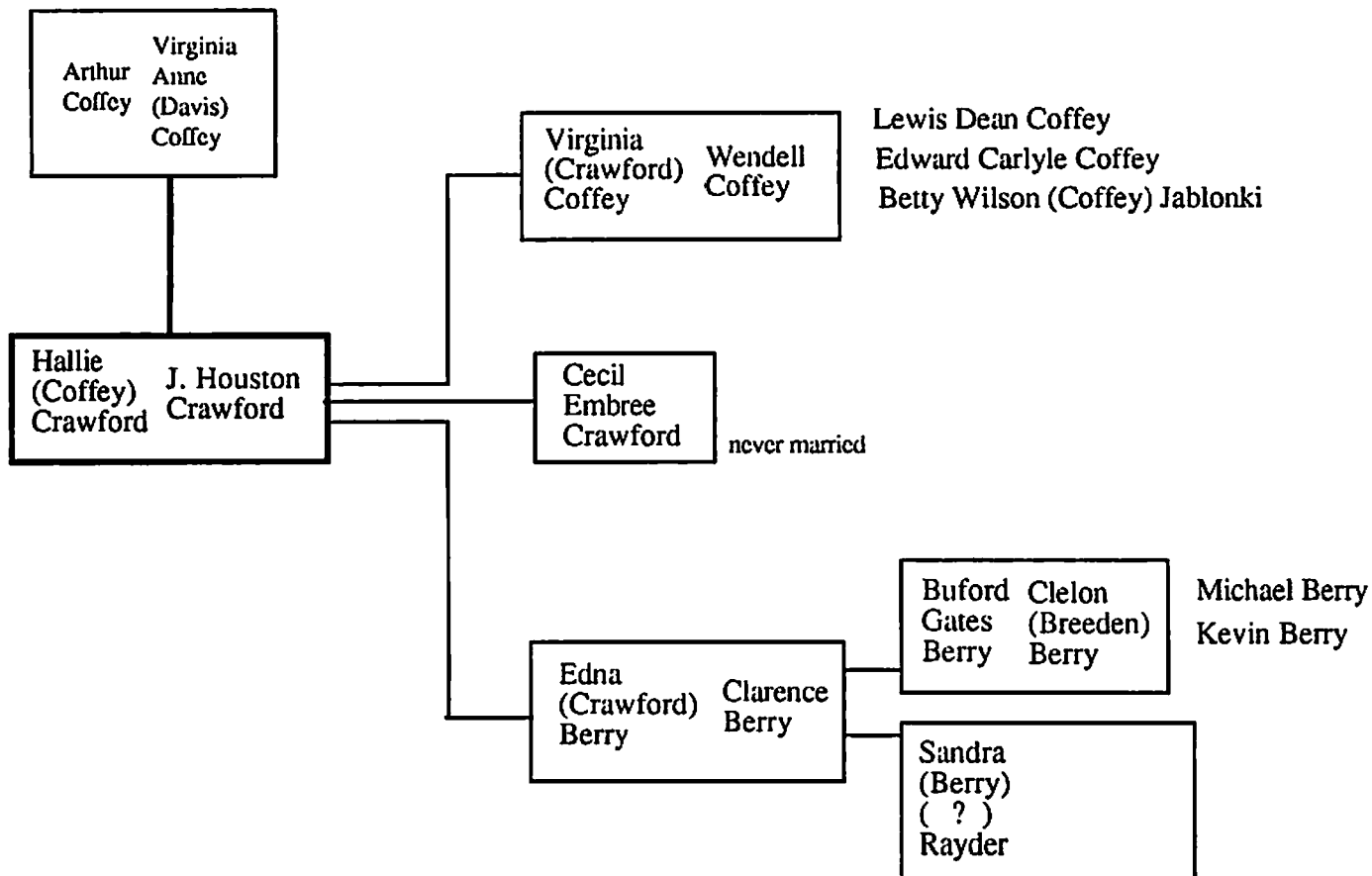

**Hallie
(Coffey)
Crawford**

Chart 1 of 1

JULY, 1992

Please return all additions and corrections to John Taylor, 1417 Claremont Avenue; Richmond, VA 23227

**Coffey Family History;
Arthur Coffey**

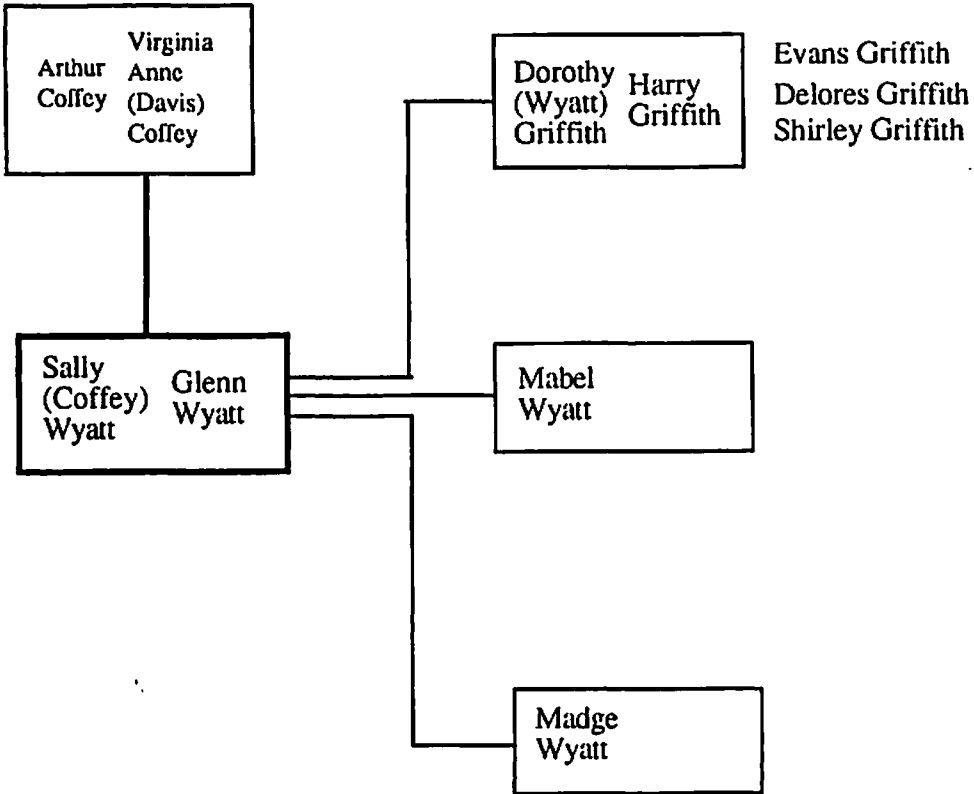

**Sally
(Coffey)
Wyatt**

Chart 1 of 1
JULY, 1992

Please return all additions and corrections to John Taylor, 1417 Claremont Avenue; Richmond, VA 23227

**Coffey Family History;
Arthur Coffey**

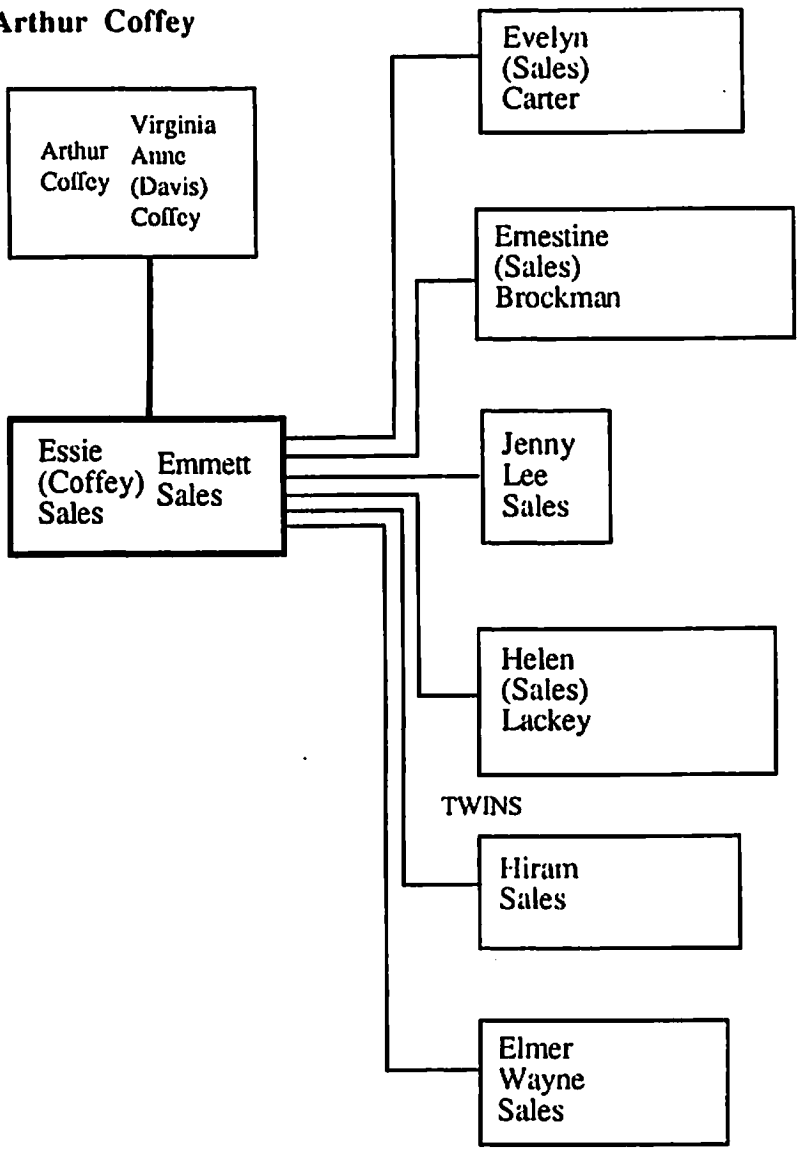

**Essie
(Coffey)
Sales**

Chart 1 of 1
JULY, 1992

Please return all additions and corrections to John Taylor, 1417 Claremont Avenue; Richmond, VA 23227

**Coffey Family History;
Arthur Coffey**

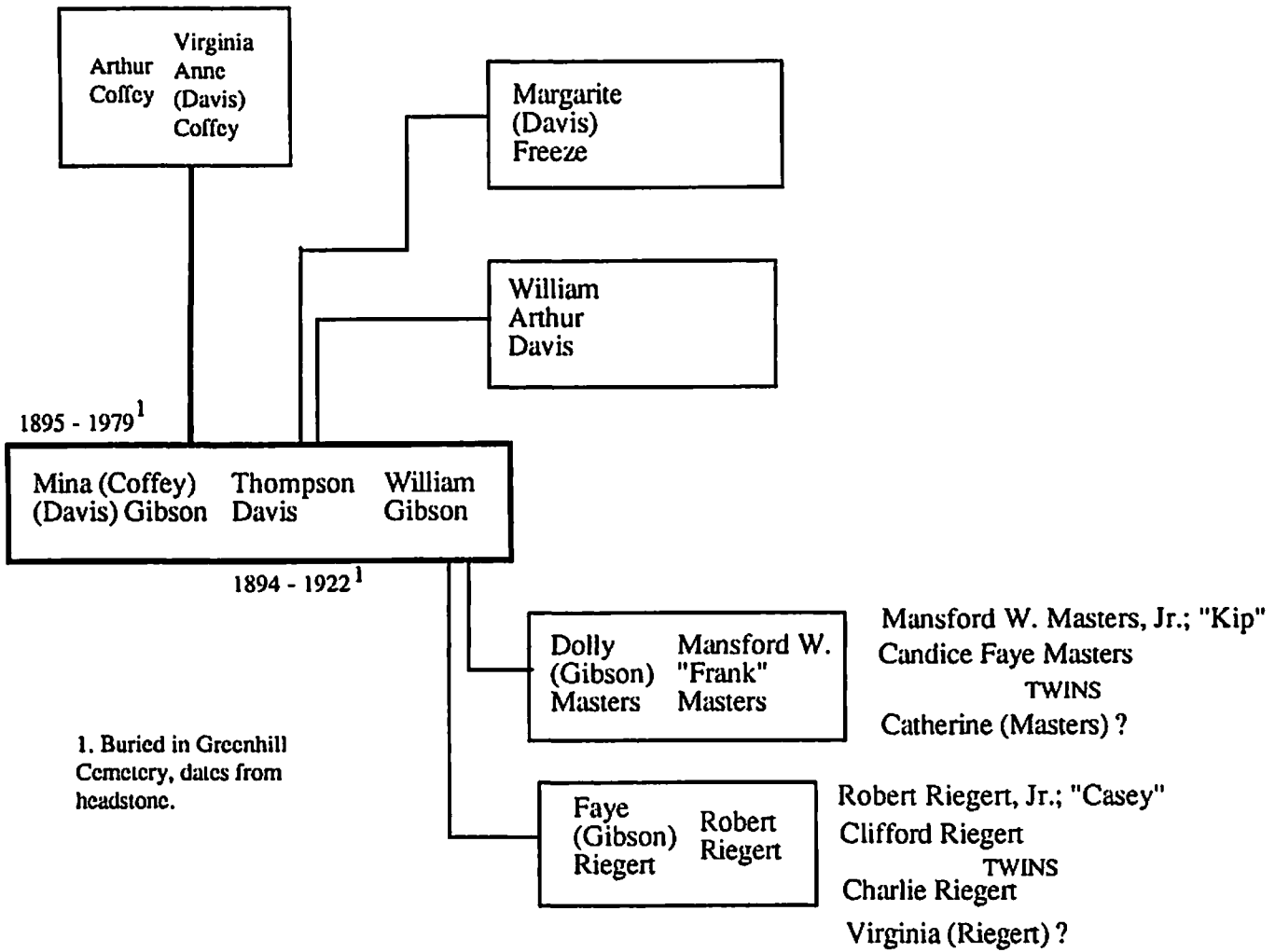

**Mina
(Coffey)
(Davis)
Gibson**

Chart 1 of 1
JULY, 1992

Please return all additions and corrections to John Taylor, 1417 Claremont Avenue; Richmond, VA 23227

**Nelson and
Rebecca
(Hamilton)
(Coffey)
Clement**

Coffey Family History;
Original Coffey Settlers in "Coffeytown"

NELSON COFFEY

Nelson Coffey's birthdate and parents have not been pin-pointed. It seems clear (although still speculation) that Nelson was Schylar's brother, but the two of them may not have been brothers with the others.

Nelson married Rebecca Hamilton, daughter of Robert Hamilton, on 5 February 1833 in Amherst County. They had Frederick, Nancy, Julia, Mathew, Pauline, and Nelson Coffey. Nelson the older must have died sometime between 1844, when little Nelson was conceived, and 1849, when Rebecca remarried, to Abram Clement. In the 1850 Census, Frederick was a 16 year old farm laborer, living with Rebecca and her new husband. Rebecca and Abram had 2 children - Missouri? and John Clement - before Abram was killed in Civil War action in Harrisonburg in 1862. By 1870, Rebecca is alone again as the head of the household. Evidently Robert Hamilton, father of Rebecca and 2 others who married into the Coffey family, died in 1841. Unhappy with the distribution of assets, Nelson and others filed suit in Amherst County for some of the property and the house. In 1842, property was awarded with some payment involved (perhaps Nelson bought out the other children's share of the estate). This is the first recorded deed of Coffey land in present day Amherst County which I have found, and it included 170 acres.

Apparently Frederick Coffey settled on a farm near Irish Gap Inns, and Nancy settled south of Dodd's Ford. Pauline's marriage record could not be located. She had 2 children, Moses and William, both named Coffee, who could have been illegitimate. She was living with Edward Drummond in Amherst County for a while, perhaps as a domestic - he was much older than she. Application was made for a marriage license when she was 36 years old, and her children were teenagers, but it was not completed. Mathew Coffey, son of Nelson, may have been a Private in Co. I of the 58th Virginia Infantry, CSA. If this is the same Mathew Coffey, he died of measles in 1862 at Stribling Springs.

(July, 1992)

Coffey Family History;
Original Coffey Settlers in "Coffeytown"
NELSON COFFEY

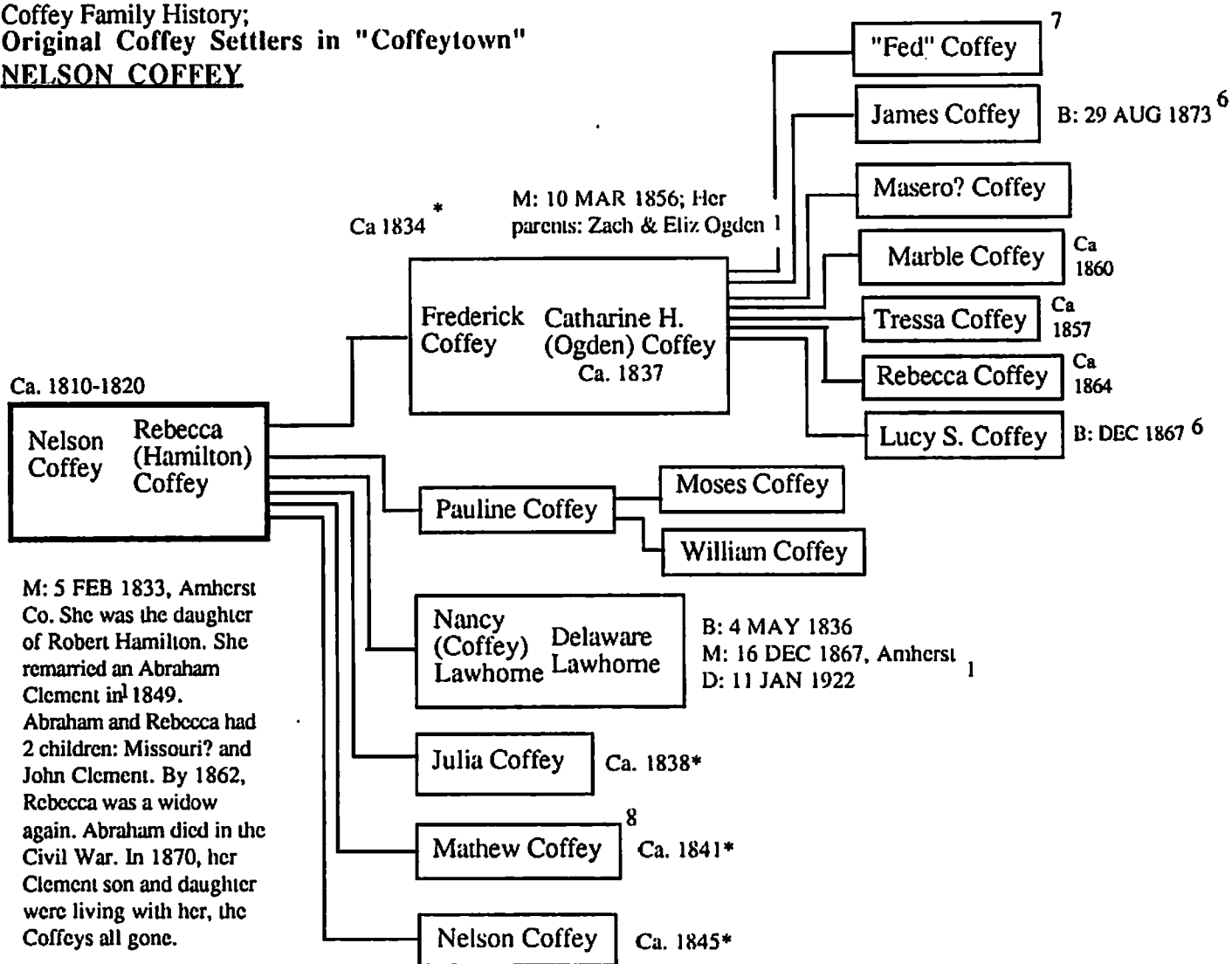

* Listings are from Census Reports.

1. From Amherst County Marriage Records in State Archives.
2. From Amherst County Death Records.
3. At age 36 Pauline Coffey applied for a marriage license in Amherst County but never returned for the marriage; man's name not clear.
4. Allwood Cemetery, dates from headstone.
5. Pauline's first husband, if any, has not been located. She was living with Edward Drummond in Amherst County with her 2 children in 1870, according to census reports.
6. Statewide Birth Index.
7. "Fed" doesn't yet show in public records although he is known to have existed. Statewide birth index shows a male born in 1868, which may have been "Fed".

8. Mathew Coffey may have been a private in Co. 1 of the 58th Virginia Infantry, CSA. If same Mathew, he died of measles at Stribling Springs in 1862.

NELSON COFFEY AND FAMILY

JULY, 1992

Please return all corrections and additions to John Taylor; 1417 Claremont Avenue; Richmond, VA 23227

**Henry and
Elizabeth
(Ogden)
Coffey**

Coffey Family History;
Original Coffey Settlers in "Coffeytown"

HENRY COFFEY

Although Henry Coffey shows for the first time in the 1850 Census as the head of a household, he may have been one of 2 boys his age living with Jordan and Elizabeth in 1840. According to Census reports, Henry was born around 1817. He married, at the age of 31, Elizabeth (Ogden) Coffey, who was older than Henry, and evidently had several children of her own from a previous marriage. Probably Henry acted as guardian to her older children and they took his surname, at least for the census reports.

Paulin J. Coffey names Henry as his guardian in his will. Avarilla Coffey Davis listed him as her father on her marriage application, although she was apparently born 2 years or so prior to Henry's marriage to Elizabeth. If there was an earlier marriage by Henry, it is not listed in Amherst, Rockbridge, Albemarle, or Nelson counties.

Nothing is known of the elder children of Elizabeth. Paulin was only 3 when Henry married Elizabeth and he probably thought of him as his father. Paulin died evidently without marrying, at the age of 24. His will named the three children of Henry as benefactors. Henry's children Avarilla, Henry F. and Mary F. all married and had children of their own.

Henry Coffey died 10 June 1871 of Colic, in Amherst County, according to the Amherst County death records. The information on the death record, including naming his parents as Charles and Jane Coffey, was given by Henry's son, Henry F. Coffey. His place of burial is unknown.

(July, 1992)

Coffey Family History;
Original Coffey Settlers in "Coffeytown"

HENRY COFFEY

* listings are from 1840, 1850,
and 1860 Census reports.

B: Ca. 1817, Nelson Co.¹
M: 10 MAR 1848 Amh Co.¹
D: 10 JUNE 1871, Colic, Amh.,²

Henry Coffey
Elizabeth McDaniel
(Ogden) Coffey

Henry Coffey's parents were
Charles and Jane Coffey, as
listed on the Death Records,
reported by his son Henry. He
was born in Nelson County.

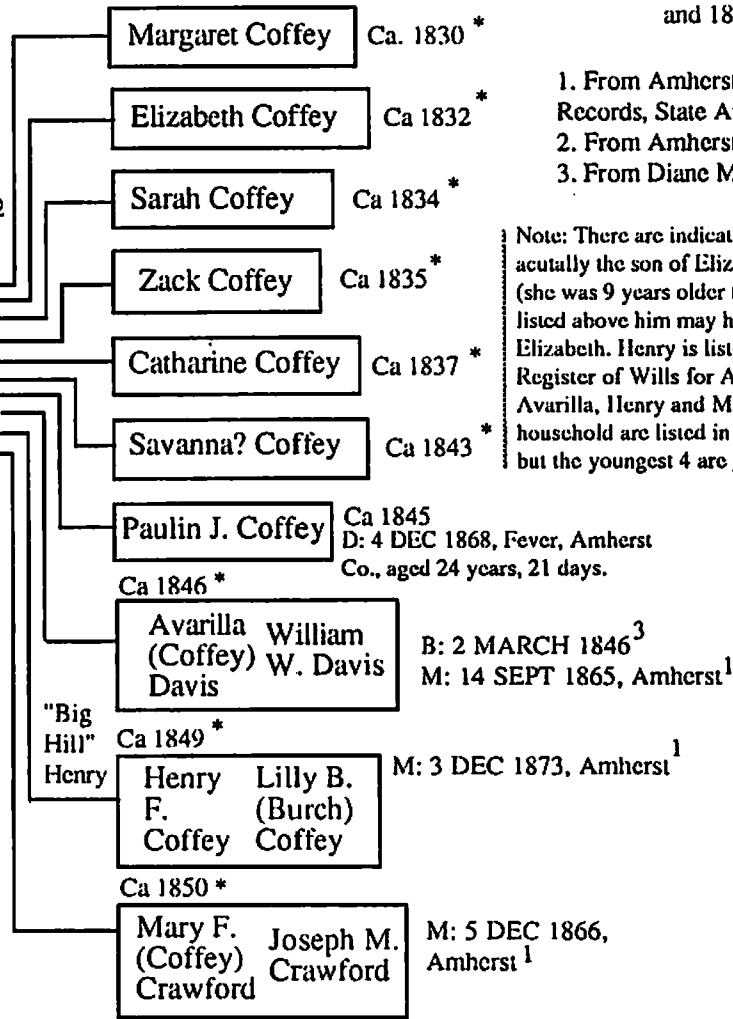

1. From Amherst County Marriage Records, State Archives.
2. From Amherst County Death Records.
3. From Diane M. Gardner.

Note: There are indications that Paulin Coffey was actually the son of Elizabeth by a previous marriage (she was 9 years older than he). Perhaps also those listed above him may have been older offspring of Elizabeth. Henry is listed as Paulin's guardian in the Register of Wills for Amherst Co. Paulin left all to Avarilla, Henry and Mary. All persons in this household are listed in the 1850 Census. By 1860, all but the youngest 4 are gone.

**HENRY
COFFEY
AND
FAMILY**

JULY, 1992

**Coffey Family History;
HENRY COFFEY**

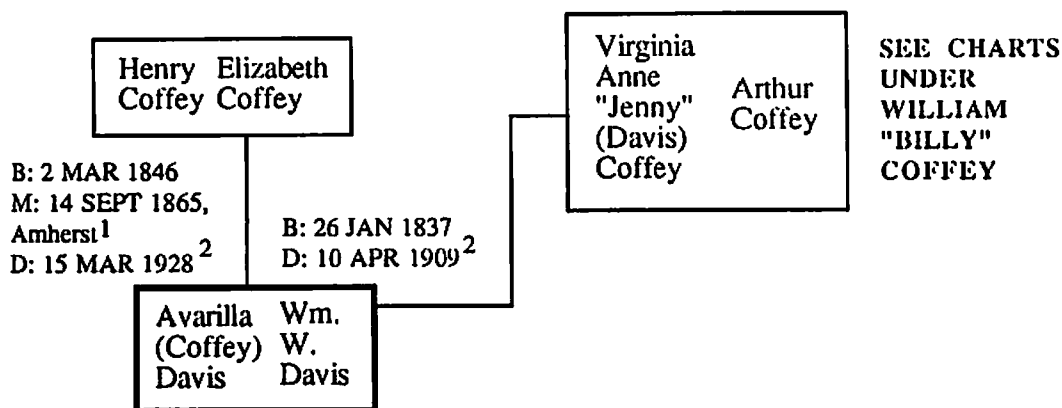

1. Amherst Co Marriage Records.
2. Buried in Bridgehill Cemetery, dates from headstones.

**AVARILLA
(COFFEY)
DAVIS**

Chronology of Coffeys in Virginia

As shown in public records researched to date

COFFEY CHRONOLOGY - VIRGINIA

(As found in the public records and secondary sources of information in genealogical publications in the Virginia State Archives in Richmond, Virginia)

- 1637 John Coffee comes to Virginia, perhaps as crewmember, maybe returning immediately. (Some believe Edward Coffee's father was named John Coffee, and this may be him.)
- 1653 Abr Cofface (sic), perhaps Abraham Coffee, came to Virginia.
- 1679,
1 MAY Peter Coffey apprenticed to John Snow in Jamaica, for four years.
- 1692 ESSEX COUNTY FORMED FROM RAPPAHANOCK CO.
- 1700 **Edward Coffey** marries Anne Powell, daughter of Thomas Powell in Essex County.
- 1706,
4 APR **Edward Coffey** granted "his freedom, corn, and clothes" from Benjamin Mosely, Essex Co.
- 1707,
10 OCT By this time **Edward Coffey** owned land from Augustine Smith, in Essex County.
- 1714,
11 NOV **Edward Coffee** and wife Ann sell land to John Barbee, land he bought from Augustine Smith; Occupation Creek, 118 acres for 5000 pounds of "lawful, sweet scented tobacco".
- 1716,
14 FEB **Edward Coffee** "writes" will described below.
- 1716,
18 July **Edward Coffey** and **John Coffey**, sons of Edward, buy 200 acres from John Mosely, Essex County; Mosely's Quarters, for 8000 # tobacco.
- 1716,
20 NOV **Edward Coffey** wills to John, Edward, Marther, Ann, Annister, Elizabeth, and his wife Ann: land, cows, etc. The bond listed Thomas Graves as one of those involved in the bonding of wife Ann as Administratrix. Land to sons if 16 and mother dead, or 18 if mother living. No mention of which one had to be 16/18, may have been twins. Date is evidently date of filing the will.

1716,
4 DEC Apparent date of actual death of **Edward Coffee** (records not clear to me).

1717,
12 JUNE Lancaster County - Inventory of estate of Hugh Coffey.

1725 **John Coffey** M Jane Graves, had **James Coffey**/Essex Co,
Baptist preacher (1729)

1731 Peter Coffee shipped to Potomack, MD prison for 14 year sentence in Colonies.

ALBERMARLE COUNTY FORMED from Goochland 1744

1744 Ann Duling, Essex Co wills prop to **Annister Coffey** and **James Coffey** her grandson.

1746,
SEPT **Chas Coffrey** sold land to Jno Grills, possibly 167 acres, in Albemarle County. Also, 1746-1748, apparently **John Coffey** then **Peter Coffey** hired Joshua Fry to survey land in Albemarle County. Not clear from this court record as to what land was surveyed.

1747 **Benjamin Coffey** born in Spotsylvania County, went to North Carolina and then to Tenn (Revolutionary War).

1748 **Peter Coffey** buys 220 Acres, Vaughan's Creek, Prince Edward County.

1748,
25 MCH **Chas and Sarah "Coffrey"**, **Jno Coffrey** mentioned in deed regarding mineral rights on N side of Buffalo Ridge (now in Amherst County).

1758,
9 MCH **Jno Coffey** sells 124 acres to **James Coffey**, heads of brs of Hardware.

1759,
29 JULY **Osborne Coffey** born in Amherst County (husband of Polly, perhaps Polly is nickname for Mary). Osborne and Mary had Jesse (Col Jesse Coffey, and state senator in KY); Mathew who died before 1830; Lucy Coffee. Richard and Osborne Coffey names also mentioned in source, but not certain if they were sons.

- 1759,
17 AUG **James Coffey** (Rev War) born in Chester, PA; later married Mary Leeper (5 APRIL 1787); they had Thomas, Mary, Jas. L., Martha, Jane, Allen, and Elizabeth Coffey.
- 1759,
16 SEPT **Reuben Coffey** born Albermarle Co, moved to NC in 1764.
- 1760Ca
1760,
8 MAY **Jno Coffey, Jr.** buys 90 acres from Lewises at head brs Michum River and Ivy Creek.
- 1760-1762 **Edward Coffey** owes Thomas Henderson, date of note, suit.

AMHERST COUNTY Formed from ALBEMARLE 1761

- 1761,
12 MCH **James Coffey and wife Elizabeth** sell 124 acres along Hardware to Jas Garland; this part of tract bought by **John Coffey, Sr.**
- 1764 **James Coffey**, planter, Albermarle Co. buys prop from Thomas Jefferson on Tye River. Witness: **Wm Coffey**
- 1764,
1 MCH **Eli Coffey**, brother of **Ambrose Coffey** was born in Albemarle County. He went to North Carolina, Tenn., KY. Served in the Revolutionary War.
- 1764,
6 SEPT **Joshua Coffey** born, Colonial Soldier in Capt. William Christian's Company of Militia, served 65 days. Also mentioned "Ambers Coffee"
- 1767 **John Coffey** witnesses: **Edmund and Reuben Coffey** buys 80 acres from Robert Hays.
- 1768 **William Coffey** buys 120 acres on Tye River from **James Coffey**. **James Coffey** sues Geo Lovel for refusal to pay debt, in Albemarle County.
- 1769,
23 FEB **Thos and Benjamin Coffey** witness land sale in Albemarle Co. Later - 8 March and 5 July - **Edward Coffey** a witness to land deal in Albemarle.

- 1770,
26 FEB Wm and Ruth Rippetoe sell 200 acres on NE side of Piney Mountain, now in Nelson Co - to Wm Hall. This land adjacent to **Edward Coffey and Cleveland Coffey.**
- 1770,
MAR **Cleveland Coffey** witnessess land deal at foot of Piney Mountain.
- 1772,
14 AUG **James Coffey** involved in court case, Albemarle Co.
- 1774,
15 FEB **William Coffey** sues James Brown.
- 1774,
18 MAR **John Coffey**, Sargeant in Virginia Regiment under Col Byrd gets certificate from Lord Dunmore for 200 acres in Fincastle County. **Ambrose Coffey** also in this - Dunmore's - War.
- 1774,
24 MARCH **John Coffey, Sr.** arrested for failure to pay Carter & Trust 2 items; executed on **Benjamin and Thomas Coffey**, his bail.
- 1777-79 **Samuel Coffey** of Va. served as Private under Geo Rogers Clark, an Albemarle County native, in Illinois.
- 1777 **Archelus Coffey** buys 120 acres from John Wade on Davis Creek.
- 1779 **William Coffey** buys prop from George Monroe, Amh Co. **James Coffey** sells to John Clarkson, Am Co.
- 1782
(Census/
Tax Rec.) **Ambrose Coffee (+1)** in Fauquier Co.?
James Coffee in Botetourt Co.
William Coffee (+2 slaves) in Buckingham County.
- 1783
(Census/
Tax Rec.) **Susannah Coffee**, Prince Edward Co, w/2 others; Census
Osborne Coffey M: Mary "Polly" Nightingale (18 FEB 1873)
Osborne (+1), William (+10) +6 Blacks, Edmund (+6) all
w/families in Am/Nelson County (Census)
Ambrose Coffee in Fauquier Co.? w/ 1 other person
James Coffee in Botetourt Co., alone
William Coffee in Buckingham Co w 2 slaves
No Benjamin Fitzgerald ,etc listed this census (1790)
- 1784 **Col. Jesse Coffey**, son of Osborne, born in Amherst County.

1787 **Thomas Coffey M Mary Knight - Amelia Co.**

1787 **TAX CENSUS: Amherst/Nelson County.**

Osborne Coffey: plus 1 young black, 2 horses, 2 cows.

William Coffey: plus 3 white males, between 16-21

 2 Blacks >16

 8 Blacks, <16

 7 horses, 6 cows.

 *William's sons: William, Nelson, Munrow Coffey.

Benjamin Fitzgerald was living in a different part of the county, had only 2 horses (note: Women were not included in the tax census)

Edmond/Edmund Coffey not listed in 1787.

1787,
27 APR **Polly Coffee** married **Jesse Robinson**; Lancaster County.

1790 **Wm Coffey, Jr. M Polly Rippetoe**, Amherst County.

1791 **Abner Coffey** marries **Christiana Kelly**; 21 July 1791; Prince Edward County.

1792 **William Coffey** and **Osborne Coffey** receive money from State of Va. and **Osborne Coffey** sued **John Fitzpatrick** for assault on his body, Amherst County; **William Coffey** sued by **Henry Martin** for money, Amherst Co.

21 JAN 1792; **William Coffey** buys 298 acres from **John Hight**, which he and his wife **Elizabeth** sell 21 SEPT 1795 to **Geo Hight**.

14 SEPT 1792 **Osborne Coffey** buys prop from **John Kesterson** at Dutch Creek, 230 acres.

30 NOV 1792 **Elizabeth Coffee**, daughter of **Sarah**, married **John Jones**, Shenandoah. **Elizabeth** thought to be sister of **Charles** and **John Coffee**.

1795 21 SEPT 1795; **Osborne Coffey** and wife **Mary** sell same 230 acres to **Thomas Nash**. Same date as **Wm** and **Eliz** sell to **George Hight**. (**Osborne** and family moved to **KY** in 1797).

19 OCT 1795: **Edmond Coffey**, et al (non-family) buys from **John Martin**; **Edmd Coffey, Jr.** and **Wm Coffey**, witnesses.

Coffey Family History
Chronology; Pg. # 6

- 1796 21 JAN 1796; Rec'd of Geo Hight an order on Major Thomas Massie for L 52-18-10; Signed by **William Coffey**.
- 1797 **Osborne Coffey** and the Nightingale family move to KY. Osborne's oldest son by Polly would not be >13 at this time, doubtful that any descendants left in Virginia.
- 1798 **Edmund Coffey** M Tildy Fitzgerald
- 1800 **Wm Coffey** M Betsey Giles
Tax records: **Edmund** and his sons Edmund and William; Ruebin; Jordan Fitzgerald (alias Coffey) in Amherst/Nelson Co.; **John Coffey** in Bedford
- 1801 **Daniel (David?) Coffey** marries Sythe Meadows; 4 NOV 1801; Prince Edward Co.
- 1802 **Edmund Coffey** M Eliza Burger
15 SEPT 1802, **William Coffey** buys from **Peter and Sarah Rippetoe** 215 acres, Tye River area.
- 1803 **Jordan Coffey** M Elizabeth Rippetoe, Amherst Co. *****
- 1806 **Pleasant Coffey** marries Judith Meadows; 6 SEPT 1806; Prince Edward Co.
- 1807 **Elizabeth Coffey** marries Stewart Jackson; 19 MAY 1807; Prince Edward Co.
- 1807,
23 SEPT Will of **Edmund Coffey**, Nelson County, mentions wife Nancy, children Edmund, William, Rueben, Emelia, Nancy, Polly.
Evidently he died 25 JULY 1808.

NELSON BECOMES SEPARATE COUNTY - 1807/1808

- 1810 CEN Nelson Co:
Edmund Coffey Jr.
Edward Coffey
Nancy Coffey
Reuben Coffey
(3) William Coffey's
Benjamin Fitzgerald
- 1810 CEN Amherst Co: No Coffeys; but **Henry Coffey** in Rockbridge Co.

Coffey Family History
Chronology; Pg. # 7

- 1814 **General John Coffee** (probably of Prince Edward County) had brigade in Tenn.
- 1818 **William John Coffey**, an alien in 1818 was authorized to buy property in New York/New Jersey.
- 1820 CEN Nelson Co:
 Edmund Coffey
 Edmund F Coffey
 Reuben Coffey
 (2) William Coffey's
 No Jordan or Benjamin Fitzgerald as heads of households.
- 1820 CEN Amherst Co: No Coffeys; No Benjamin Fitzgerald.
- 1827 31 DEC 1827; **Hudson Coffey** deeds mare, beds and furniture to **Jordan Coffey**, Amh Co.
- 1830 CEN Amherst: **Jordan Coffey** and 10 others in same household now in Amherst County.***** No Benjamin Fitzgerald in Amh
- 1830 **John Jack Coffey**, Sr. M Betsy Duff; 18 JAN 1830, Amherst Co.
- 1832 **Schylar Coffey** M Elizabeth Hamilton; 30 JAN 1832, Amh Co.
- 1833 **Nelson Coffey** M Rebecca Hamilton; 5 FEB 1833, Amh Co.
- 1834 **Jane Coffey** M Meredith Allen; 21 APR 1834, Amh Co. They went to West Virginia.
- 1835 **Elizabeth Coffey** M John Hamilton; 5 MAY 1835, Amh Co.
Susanna Coffey M John Crawford; 9 SEPT 1835, Amh Co
Billy Coffey M Sarah Crawford; 24 SEPT 1835, Amh Co.
- 1840 **Mary Coffee Hutchins**, daughter of General John Coffee, had sisters **Rachel J. Coffee** and **Catherine Coffee**; Mary in Alabama in 1841. Coffees in AL as early as 1838.
- 1840 CEN Amherst County: **Nelson +4; William +3; John +7; Schylar + 4; Jordan +3; and Ruben P. Coffey** and presumably his wife were all in Amherst County in 1840. Ruben was not in the same grouping and is thought to have lived in a different part of the county.
- 1 FEB 1841 Will of Andrew Jackson Hutchings mentions his wife, daughter of Gen John Coffee was **Mary Coffee Hutchings**, also mentions Alexander D. Coffee. These folks in Lauderdale

County Courthouse, Florence, Alabama.

- 1841, 23 OCT **Edmund F Coffey**, Nelson Co, certifies Wm Campbell is oldest child and his age for Revolutionary War pension.
- 1842 21 NOV 1842; **Nelson Coffey** et al get 170 acres from **Robert Hamilton**, where he lived and died; something to do with \$475 bid or 1841 court case - Estate?
- 1848 **Henry Coffey** M Elizabeth Ogden; 10 MAR 1848, Amh Co.
- 1850 CEN Too numerous to list here, but included **John and Betsey; Jordan and Betsey; William and Sally; Schylar and Betsey; Henry and Elizabeth; Joseph and Ruth; and 16 year-old Frederick Coffee.**
- 1855 **Hudson Coffey** M Mahala Green Lane; 20 SEPT 1855, Amh Co.
- 1859 **William Coffee** settled tract of land in Texas, then went to Jackson Co, Alabama; no info on where he came from.
- 1860 CEN Too numerous to list here, but included **Charles and Sarah Jane; Henry and Elizabeth; John and Elizabeth; Billy and Sally; Frederick and Catherine; Hudson and Martha; Meredith and Mildred; Schylar Coffey** but not his wife; all as heads of a household.
- 1867 **William B Coffey**, son of **Edmond and Elizabeth Coffey** drowned at age of 60 in April, 1867. He married Marty Masten on 13 NOV 1824, in Nelson County. Note: Billy Coffey shows up in Amherst Co 1870 Census. This is a different William B. Elizabeth was a Burger before marriage.
- 1870 CEN Too numerous to list here.

End of Chronology